

GEYER



2021

Lighting Catalogue

GEYER

GEYER

A full range of LED lamps and LED lighting fixtures that cover all Lighting applications for Indoor and Outdoor use have been created by **GEYER HELLAS**. There is an everywhere solution for industrial, commercial etc working area.

Lamps

Filament clear, matt and vintage lamp series are the ideal solution for decorative and architectural lighting, mostly in coffee shops, restaurants, parks and houses. They stand out for their manufacturing quality and design variety. Their dimming function can help even with the most specialized and unique demands. Public illumination lamps are highly reliable while ensuring high levels of energy saving. Finally, they ease the functionality and maintenance of the municipality network.

Architectural Illumination

Our company developed pioneering lighting fixtures, which provide solutions for the most demanding architectural applications. An important new product is the INNOVA linear track light that can be installed on a track rail and in combination with the Spot track lights, can be the best solution for shopping stores, supermarkets etc. either with general or directional illumination. Plaster lightings and spots are the ideal solution for homes as well as for every difficult project. Pendants stand out for their quality, simplicity and aesthetics. New panels and floodlights, with 5 years warranty, are now here to complement our product range. Our outdoor lighting lamps have high quality standards. They are perfect for private and public areas and can contribute to the creation of architectural masterpieces through their elegance and robustness.

Public Illumination

Street lighting lamps can achieve major energy savings compared to the classic mercury and sodium lamps. Specifically, these savings are more than 70%. The various types of lighting which they have make them ideal for high speed roads urban roads, urban and industrial areas and parking lots. Public square, park and garden lights combine elegant design with the most advanced LED technology. Their traditional and modern design is remarkable. They are built to endure the most difficult conditions while being a premium solution for park, pavement and marina lighting. Finally, stadium lights are ideal for every pitch and all the required lighting levels.



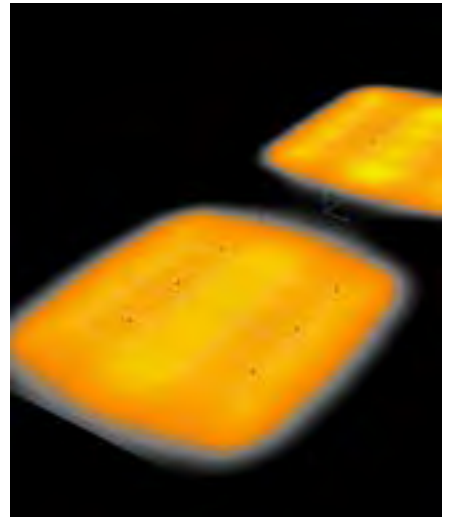
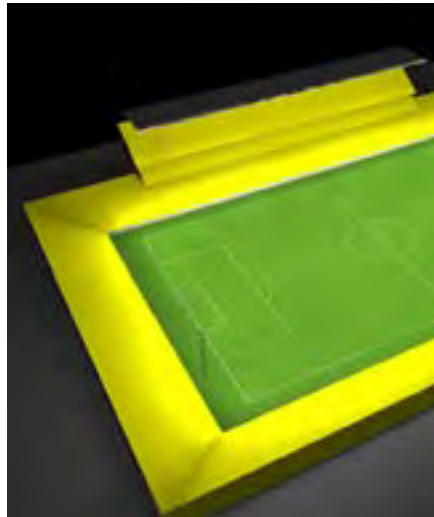
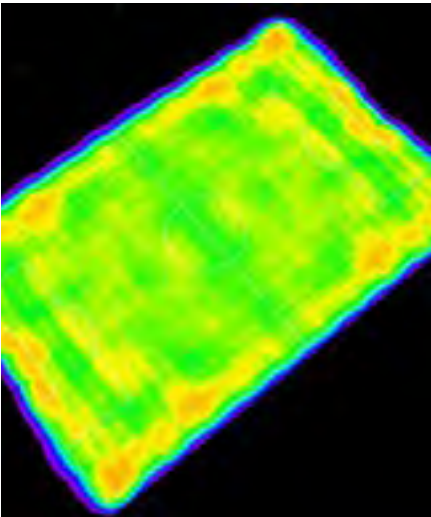

Our company provides **PROFESSIONAL PHOTOMETRIC DESIGN** for several public sectors, including outdoor and indoor lighting, as well as any other lighting solution for high architectural requirements.





CHAPTER A

Lamps

LED Filament	7
Crown Mirror Filament	16
LED Vintage Lamps	18
LED Color Lamps	22
LED Lamps	26
LED Special Lamps	44
LED Street Lamps	51
LED Tubes	54
Halogen Lamps	63
Conversion Lamp Holders	70
Fluorescent Lamps	73
Fluorescent UV-A Lamps	76
Fluorescent Blacklight Lamps	79
Fluorescent Germicidal UV-C Lamps	82
High Pressure Lamps	85

CHAPTER B

Architecture Illumination

Downlights	89
LED Panels	97
Lighting Fixtures	110
PIR Sensors	117
Highbays	119
LED Canopy	124
Street Lights	126
LED Floodlights	129
LED Strips	141



2021

ral
on

CHAPTER C Public Lighting

Track Lights	176
Linear Lights	200
Spots	206
Gypsum Lights	223
Pendant Lights	241
Outdoor Lights	257
Sports Lights Stadium & Arena	289

Street Lights	294
Industrial Lights for Airports, Ports, Logistics	304
Tunnel Lights	306
City Lights	308

GEYER

CHAPTER A
Lamps



LED Filament



Filament Bulb 4W



CODE	TYPE	WATT	CCT	BASE	LUMEN	
LFAW274	CLEAR	4	2700	E27	470	10/100
LFAC274	CLEAR	4	4000	E27	470	10/100

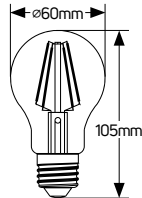

Filament Bulb 6W



CODE	TYPE	WATT	CCT	BASE	LUMEN	
LFAW276	CLEAR	6	2700	E27	800	10/100
LFAC276	CLEAR	6	4000	E27	800	10/100
LFAW276D Dimmable	CLEAR	6	2700	E27	600	10/100
LFAC276D Dimmable	CLEAR	6	4000	E27	600	10/100

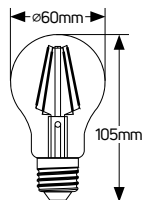

Filament Bulb 8W



CODE	TYPE	WATT	CCT	BASE	LUMEN	
LFAW278	CLEAR	8	2700	E27	900	10/100
LFAC278	CLEAR	8	4000	E27	900	10/100
LFAW278D Dimmable	CLEAR	8	2700	E27	850	10/100
LFAC278D Dimmable	CLEAR	8	4000	E27	850	10/100

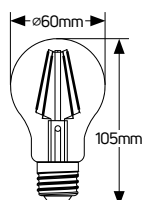

Filament Bulb 12W



CODE	TYPE	WATT	CCT	BASE	LUMEN	
LF AW2712	CLEAR	12	2700	E27	1521	10/100
LF AC2712	CLEAR	12	4000	E27	1521	10/100

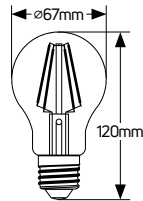

Filament Candle 4W



CODE	TYPE	WATT	CCT	BASE	LUMEN	
LF CW144	CLEAR	4	2700	E14	470	10/100
LF CC144	CLEAR	4	4000	E14	470	10/100
LF CW144D Dimmable	CLEAR	4	2700	E14	380	10/100
LF CC144D Dimmable	CLEAR	4	4000	E14	380	10/100

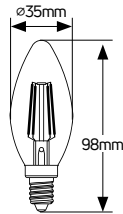

Filament Mini Globe 4W E14



CODE	TYPE	WATT	CCT	BASE	LUMEN	
LF GLW144	CLEAR	4	2700	E14	470	10/100
LF GLC144	CLEAR	4	4000	E14	470	10/100
LF GLW144D Dimmable	CLEAR	4	2700	E14	380	10/100
LF GLC144D Dimmable	CLEAR	4	4000	E14	380	10/100

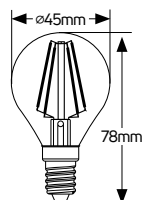

Filament Mini Globe 4W E27



CODE	TYPE	WATT	CCT	BASE	LUMEN	
LFGLW274	CLEAR	4	2700	E27	470	10/100
LFGLC274	CLEAR	4	4000	E27	470	10/100
LFGLW274D Dimmable	CLEAR	4	2700	E27	380	10/100
LFGLC274D Dimmable	CLEAR	4	4000	E27	380	10/100

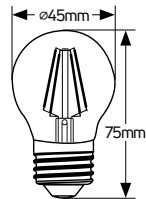

Filament Globe G95 5W



CODE	TYPE	WATT	CCT	BASE	LUMEN	
LFGNW275	CLEAR	5	2700	E27	600	1/50
LFGNC275	CLEAR	5	4000	E27	600	1/50

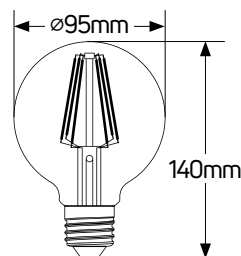

Filament Globe G95 12W



CODE	TYPE	WATT	CCT	BASE	LUMEN	
LFG95NW2712	CLEAR	12	2700	E27	1521	1/50
LFG95NC2712	CLEAR	12	4000	E27	1521	1/50

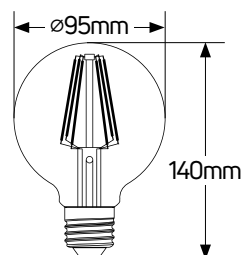

Filament Globe G125 8W



CODE	TYPE	WATT	CCT	BASE	LUMEN	
LFGNW278	CLEAR	8	2700	E27	900	5/20
LFGNC278	CLEAR	8	4000	E27	900	5/20
LFGNW278D Dimmable	CLEAR	8	2700	E27	700	5/20
LFGNC278D Dimmable	CLEAR	8	4000	E27	700	5/20

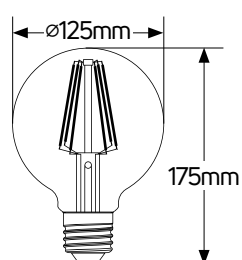

Filament Globe G125 12W



CODE	TYPE	WATT	CCT	BASE	LUMEN	
LFGNW2712	CLEAR	12	2700	E27	1521	5/20
LFGNC2712	CLEAR	12	4000	E27	1521	5/20

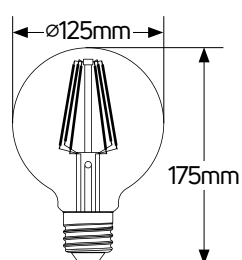

Filament Bulb 4W



CODE	TYPE	WATT	CCT	BASE	LUMEN	
LFSAW274	MATT	4	2700	E27	400	10/100
LFSAC274	MATT	4	4000	E27	400	10/100

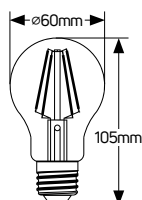

Filament Bulb 6W



CODE	TYPE	WATT	CCT	BASE	LUMEN	
LFSAW276	MATT	6	2700	E27	750	10/100
LFSAC276	MATT	6	4000	E27	750	10/100

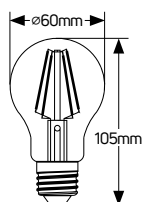

Filament Bulb 8W



CODE	TYPE	WATT	CCT	BASE	LUMEN	
LFSAW278	MATT	8	2700	E27	850	10/100
LFSAC278	MATT	8	4000	E27	850	10/100

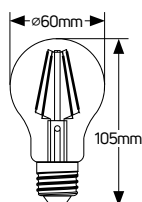

Filament Candle 4W



CODE	TYPE	WATT	CCT	BASE	LUMEN	
LFCSW144	MATT	4	2700	E14	400	10/100
LFCS144	MATT	4	4000	E14	400	10/100

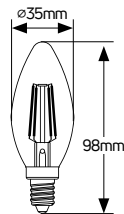

Filament Mini Globe 4W E14



CODE	TYPE	WATT	CCT	BASE	LUMEN	
LFGSW144	MATT	4	2700	E14	400	10/100
LFGSC144	MATT	4	4000	E14	400	10/100

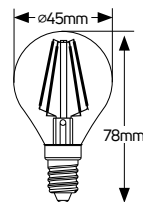

Filament Mini Globe 4W E27



CODE	TYPE	WATT	CCT	BASE	LUMEN	
LFGSW274	MATT	4	2700	E27	400	10/100
LFGSC274	MATT	4	4000	E27	400	10/100

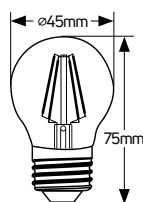

Filament Globe G95 5W



CODE	TYPE	WATT	CCT	BASE	LUMEN	
LFGNSW275	MATT	5	2700	E27	550	1/50
LFGNSC275	MATT	5	4000	E27	550	1/50

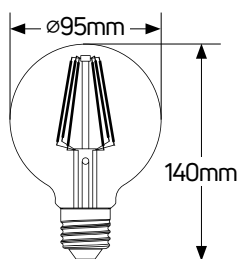

Filament Globe G125 8W



CODE	TYPE	WATT	CCT	BASE	LUMEN	
LFGNSW278	MATT	8	2700	E27	850	5/20
LFGNSC278	MATT	8	4000	E27	850	5/20

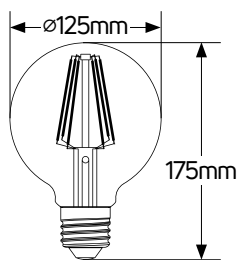

Filament R50 5W



CODE	TYPE	WATT	CCT	BASE	LUMEN	
LFKWE14	R50	5	2700	E14	470	1/5/100
LFKCE14	R50	5	4000	E14	470	1/5/100

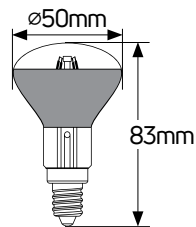

Filament R63 8W



CODE	TYPE	WATT	CCT	BASE	LUMEN	
LFKWE27	R63	8	2700	E27	650	1/5/100
LFKCE27	R63	8	4000	E27	650	1/5/100

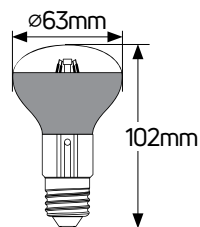

Filament R80 11W



CODE	TYPE	WATT	CCT	BASE	LUMEN	
LFK80WE27	R80	11	2700	E27	980	1/10/50
LFK80CE27	R80	11	4000	E27	980	1/10/50

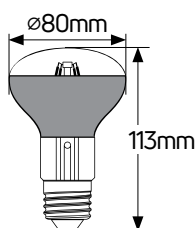



Crown Mirror Filament

Crown Mirror Filament Bulb



CODE		WATT	CCT	BASE	LUMEN	
LFMA276SD Dimmable	●	6	2700	E27	480	10/50
LFMA276GD Dimmable	●	6	2700	E27	480	10/50
LFMA276CD Dimmable	●	6	2700	E27	480	10/50

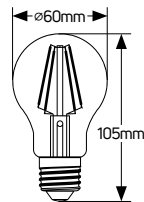

Globe G95 Crown Mirror Filament



CODE		WATT	CCT	BASE	LUMEN	
LFGNM276SD Dimmable	●	6	2700	E27	480	1/20
LFGNM276GD Dimmable	●	6	2700	E27	480	1/20
LFGNM276CD Dimmable	●	6	2700	E27	480	1/20

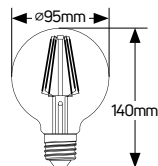

Globe G125 Crown Mirror Filament



CODE		WATT	CCT	BASE	LUMEN	
LFGBM276SD Dimmable	●	6	2700	E27	480	1/20
LFGBM276GD Dimmable	●	6	2700	E27	480	1/20
LFGBM276CD Dimmable	●	6	2700	E27	480	1/20

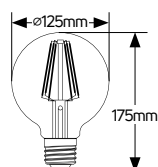

LED Vintage Lamps





ST64 Vintage 4W, 5W



CODE	WATT	CCT	BASE	LUMEN	
LVST64	4	2000	E27	350	10/50
LVST64D Dimmable	5	2000	E27	350	10/50

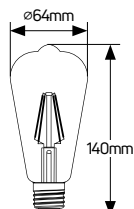

Vintage Bulb 6W



CODE	WATT	CCT	BASE	LUMEN	
LVA27	6	2000	E27	500	10/100
LVA27D Dimmable	6	2000	E27	500	10/100

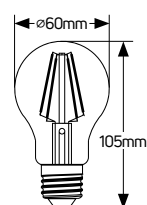

Vintage Candle 4W



CODE	WATT	CCT	BASE	LUMEN	
LVC14	4	2000	E14	320	10/100
LVC14D Dimmable	4	2000	E14	320	10/100

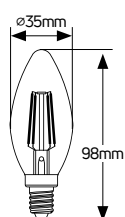



T30-185 Vintage 6W



CODE	WATT	CCT	BASE	LUMEN	
LVT30-185	6	2000	E27	500	10/50
LVT30-185D Dimmable	6	2000	E27	500	10/50

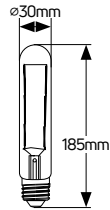

T30-225 Vintage 6W



CODE	WATT	CCT	BASE	LUMEN	
LVT30-225	6	2000	E27	500	10/50
LVT30-225D Dimmable	6	2000	E27	500	10/50

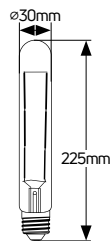

T45 Vintage 4W



CODE	WATT	CCT	BASE	LUMEN	
LVT45	4	2000	E27	320	10/100
LVT45D Dimmable	4	2000	E27	320	10/100

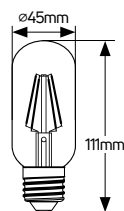

BT75 Vintage 6W



CODE	WATT	CCT	BASE	LUMEN	
LVBT75	6	2000	E27	500	10/50
LVBT75D Dimmable	6	2000	E27	500	10/50

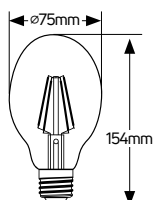

Vintage Globe G95 6W



CODE	WATT	CCT	BASE	LUMEN	
LVG95	6	2000	E27	500	10/50
LVG95D Dimmable	6	2000	E27	500	10/50

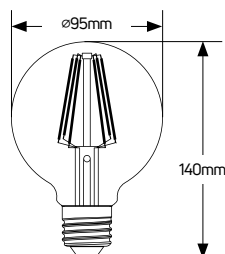

Vintage Globe G125 6W, 5W



CODE	WATT	CCT	BASE	LUMEN	
LVG125	6	2000	E27	500	1/20
LVG125D Dimmable	5	2000	E27	500	1/20

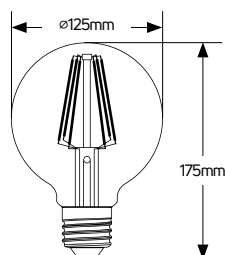

LED Color Lamps



T20 1.3W Green



CODE	WATT	CCT	BASE	LUMEN	
LNL-G	1.3	●	E14	70	10/200

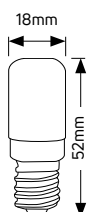

T20 1.3W Yellow



CODE	WATT	CCT	BASE	LUMEN	
LNL-Y	1.3	●	E14	70	10/200

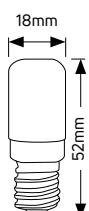

T20 1.3W Blue



CODE	WATT	CCT	BASE	LUMEN	
LNL-B	1.3	●	E14	70	10/200

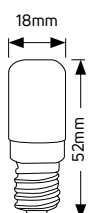

T20 White

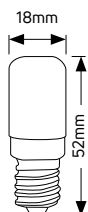

CODE	WATT	CCT	BASE	LUMEN	
LNL-WW	1.3	3000	E14	70	10/200
LFR2-C	2	4000	E14	180	10/200

T20 1.3W Red

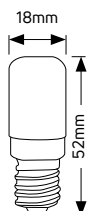

CODE	WATT	CCT	BASE	LUMEN	
LNL-R	1.3		E14	70	10/200

Filament Color Bulb Blue

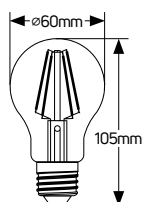

CODE	WATT	CCT	BASE	LUMEN	
LFA274-B	4		E27	120	10/50

Filament Color Bulb Red



CODE	WATT	CCT	BASE	LUMEN	
LFA274-R	4	●	E27	60	10/50

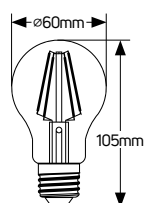

Filament Color Bulb Green



CODE	WATT	CCT	BASE	LUMEN	
LFA274-G	4	●	E27	120	10/50

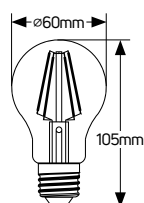

Filament Color Bulb Yellow



CODE	WATT	CCT	BASE	LUMEN	
LFA274-Y	4	●	E27	300	10/50

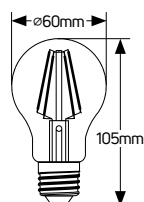

LED Lamps



LED Bulb 5.5W



CODE	WATT	CCT	BASE	LUMEN	
LAWE276E	5.5	3000	E27	470	1/10/50
LACE276E	5.5	4000	E27	470	1/10/50
LADE276E	5.5	6500	E27	470	1/10/50

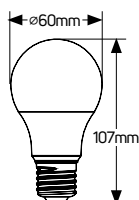

LED Bulb 8.5W



CODE	WATT	CCT	BASE	LUMEN	
LAWE279E	8.5	3000	E27	806	1/10/50
LACE279E	8.5	4000	E27	806	1/10/50
LADE279E	8.5	6500	E27	806	1/10/50

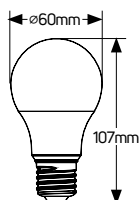

LED Bulb 10W



CODE	WATT	CCT	BASE	LUMEN	
LAWE2710E	10	3000	E27	1055	1/10/50
LACE2710E	10	4000	E27	1055	1/10/50
LADE2710E	10	6500	E27	1055	1/10/50

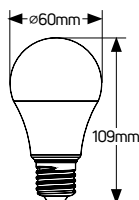

LED Bulb 11W



CODE	WATT	CCT	BASE	LUMEN	
LAWE2711E	11	3000	E27	1250	1/10/50
LACE2711E	11	4000	E27	1250	1/10/50
LADE2711E	11	6500	E27	1250	1/10/50

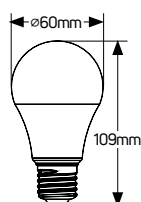

LED Bulb 13.5W



CODE	WATT	CCT	BASE	LUMEN	
LAWE2714E	13.5	3000	E27	1521	1/10/50
LACE2714E	13.5	4000	E27	1521	1/10/50
LADE2714E	13.5	6500	E27	1521	1/10/50

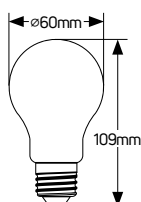

LED Bulb 16W Premium



CODE	WATT	CCT	BASE	LUMEN	
LAWE2716	16	3000	E27	1600	1/10/50
LACE2716	16	4000	E27	1650	1/10/50
LADE2716	16	6500	E27	1700	1/10/50

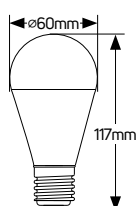

LED Candle 2.5W



CODE	WATT	CCT	BASE	LUMEN	
LCWE143E	2.5	3000	E14	250	1/10/50
LCCE143E	2.5	4000	E14	250	1/10/50
LCDE143E	2.5	6500	E14	250	1/10/50

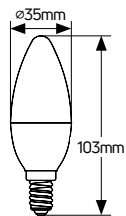

LED Candle 5W



CODE	WATT	CCT	BASE	LUMEN	
LCWE145E	5	3000	E14	470	1/10/50
LCCE145E	5	4000	E14	470	1/10/50
LCDE145E	5	6500	E14	470	1/10/50

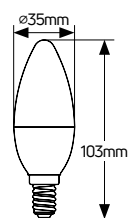

LED Mini Globe 2.5W E14



CODE	WATT	CCT	BASE	LUMEN	
LGLWE143E	2.5	3000	E14	250	1/10/50
LGLCE143E	2.5	4000	E14	250	1/10/50
LGLDE143E	2.5	6500	E14	250	1/10/50

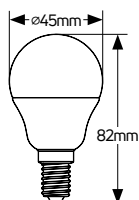

LED Mini Globe 5W E14



CODE	WATT	CCT	BASE	LUMEN	
LGLWE145E	5	3000	E14	470	1/10/50
LGLCE145E	5	4000	E14	470	1/10/50
LGLDE145E	5	6500	E14	470	1/10/50

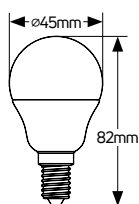

LED Mini Globe 2.5W E27



CODE	WATT	CCT	BASE	LUMEN	
LGLWE273E	2.5	3000	E27	250	1/10/50
LGLCE273E	2.5	4000	E27	250	1/10/50
LGLDE273E	2.5	6500	E27	250	1/10/50

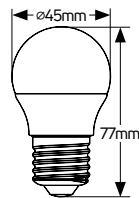

LED Mini Globe 5W E27



CODE	WATT	CCT	BASE	LUMEN	
LGLWE275E	5	3000	E27	470	1/10/50
LGLCE275E	5	4000	E27	470	1/10/50
LGLDE275E	5	6500	E27	470	1/10/50

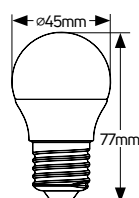

LED Globe G95 12W Premium



CODE	WATT	CCT	BASE	LUMEN	
LGNWE2712	12	3000	E27	1050	1/5/20
LGNCE2712	12	4000	E27	1100	1/5/20
LGNDE2712	12	6500	E27	1150	1/5/20

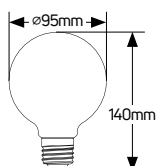

LED Globe G120 14W Premium



CODE	WATT	CCT	BASE	LUMEN	
LGNWE2714	14	3000	E27	1200	1/5/20
LGNCE2714	14	4000	E27	1250	1/5/20
LGNDE2714	14	6500	E27	1300	1/5/20

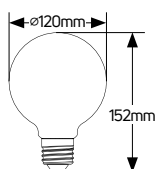

LED Globe G120 18/20W Premium



CODE	WATT	CCT	BASE	LUMEN	
LGNWE2718	18	3000	E27	1800	1/5/20
LGNCE2718	18	4000	E27	1850	1/5/20
LGNDE2718	18	6500	E27	1900	1/5/20
LGNWE2720	20	3000	E27	2450	1/5/20
LGNCE2720	20	4000	E27	2500	1/5/20
LGNDE2720	20	6500	E27	2550	1/5/20

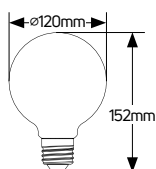

LED Stick T37



CODE	WATT	CCT	BASE	LUMEN	
LT37W9MAS	9	3000	E27	810	10/100
LT37C9MAS	9	4000	E27	810	10/100

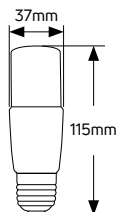

LED Bulb 12-30V AC/DC



CODE	WATT	CCT	BASE	LUMEN	
LAW2781230	8	3000	E27	650	1/5/100
LACE2781230	8	4000	E27	650	1/5/100

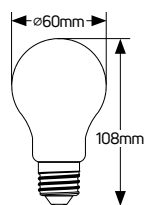

LED Bulb 24-42V AC/DC



CODE	WATT	CCT	BASE	LUMEN	
LAW278-42	8	3000	E27	640	1/10/50
LACE278-42	8	4000	E27	660	1/10/50

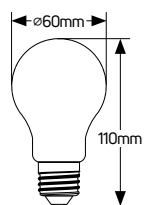

LED Bulb 11W, Motion Sensor



CODE	WATT	CCT	BASE	LUMEN	
LAWE2711MS	11	3000	E27	900	1/10/50
LACE2711MS	11	4000	E27	900	1/10/50

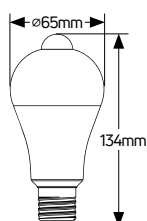

LED Bulb 9W, Sensor Day/Night



CODE	WATT	CCT	BASE	LUMEN	
LAWE279DN	9	3000	E27	800	1/10/50
LACE279DN	9	4000	E27	830	1/10/50

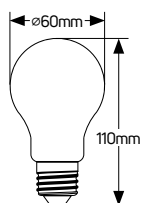

LED Bulb 12W, Sensor Day/Night



CODE	WATT	CCT	BASE	LUMEN	
LAWE2712DN	12	3000	E27	1100	1/10/50
LACE2712DN	12	4000	E27	1100	1/10/50

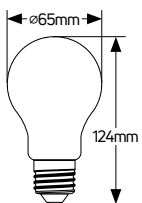

High Power Economy



CODE	WATT	CCT	BASE	LUMEN	DIMENSIONS (mm)		📦
					A	B	
LHPC2720S	20	4000	E27	1800	80	150	1/20
LHPC2730S	30	4000	E27	2700	100	173	1/20
LHPC2740S	40	4000	E27	3600	120	215	1/20
LHPC2750S	50	4000	E27	4500	140	230	1/16
LHPC2760SA	60	4000	E27	5400	140	258	1/8
LHPC2770SA	70	4000	E27/E40	6300	140	258	1/8
LHPC2780SA	80	4000	E27/E40	7200	150	260	1/8

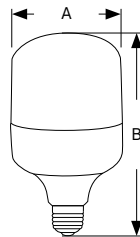

HighPower Premium



CODE	WATT	CCT	BASE	LUMEN	DIMENSIONS (mm)		📦
					A	B	
LHPC2718	18	4000	E27	1700	80	150	1/10
LHPC2727	27	4000	E27	2400	100	185	1/20
LHPC2736	36	4000	E27	3200	120	214	1/20

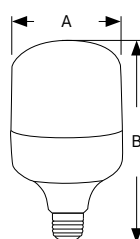

LED PAR16 3W



CODE	WATT	CCT	BASE	LUMEN	
LHGW3E	3	3000	GU10	250	1/10/50
LHGC3E	3	4000	GU10	250	1/10/50
LHGD3E	3	6500	GU10	250	1/10/50

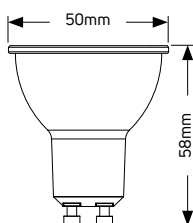

LED PAR16 6W



CODE	WATT	CCT	BASE	LUMEN	
LHGW6E	6	3000	GU10	470	1/10/50
LHGC6E	6	4000	GU10	470	1/10/50
LHGD6E	6	6500	GU10	470	1/10/50

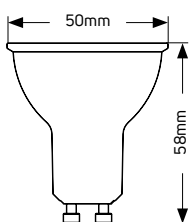

LED PAR16 5W, 36°



CODE	WATT	CCT	BASE	LUMEN	
LHW536E	5	3000	GU10	470	1/10/50
LHGC536E	5	4000	GU10	470	1/10/50
LHGD536E	5	6500	GU10	470	1/10/50

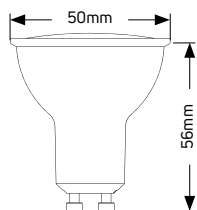

LED PAR16 5W, 36°



CODE	WATT	CCT	BASE	LUMEN	
LHW538DE	5	3000	GU10	480	10/50
LHGC538DE	5	4000	GU10	500	10/50

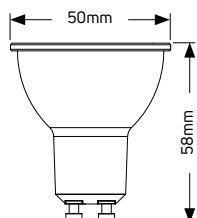

LED PAR16 42V AC/DC



CODE	WATT	CCT	BASE	LUMEN	
LHW5-42	5	3000	GU10	400	1/10/50
LHGC5-42	5	4000	GU10	400	1/10/50

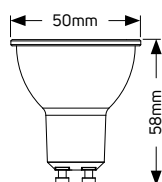

LED PAR16 Glass 5W, 36°



CODE	WATT	CCT	BASE	LUMEN	
LHG53827E	5	2700	GU10	460	10/100
LHG53830E	5	3000	GU10	460	10/100
LHG53840E	5	4000	GU10	460	10/100
LHG53865E	5	6500	GU10	460	10/100

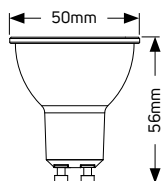

LED PAR16 Glass 5W, 36°, Dimmable



CODE	WATT	CCT	BASE	LUMEN	
LHG53827DE Dimmable	5	2700	GU10	400	10/100
LHG53830DE Dimmable	5	3000	GU10	400	10/100
LHG53840DE Dimmable	5	4000	GU10	400	10/100

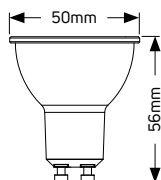

LED PAR16 Glass 5W, 60°



CODE	WATT	CCT	BASE	LUMEN	
LHG56027E	5	2700	GU10	460	10/100
LHG56030E	5	3000	GU10	460	10/100
LHG56040E	5	4000	GU10	460	10/100
LHG56065E	5	6500	GU10	460	10/100

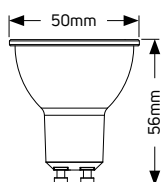

LED PAR16 Glass 5W, 120°



CODE	WATT	CCT	BASE	LUMEN	
LHG512027E	5	2700	GU10	550	10/100
LHG512030E	5	3000	GU10	550	10/100
LHG512040E	5	4000	GU10	550	10/100
LHG512065E	5	6500	GU10	550	10/100

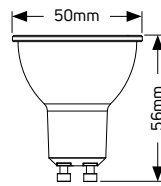

MR11 2W Glass



CODE	WATT	CCT	BASE	LUMEN	
LMR11W	2	3000	GU4	150	1/10/200
LMR11C	2	4000	GU4	160	1/10/200
LMR11D	2	6500	GU4	160	1/10/200

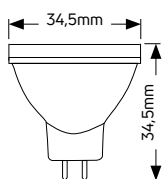

MR16 5W Glass, 36°



CODE	WATT	CCT	BASE	LUMEN	
LHM53830E	5	3000	GU5.3	400	1/10/100
LHM53840E	5	4000	GU5.3	410	1/10/100

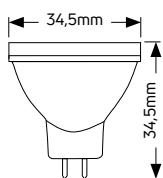

MR16 6W



CODE	WATT	CCT	BASE	LUMEN	
LHMW6E	6	3000	GU5.3	470	1/10/50
LHMC6E	6	4000	GU5.3	470	1/10/50

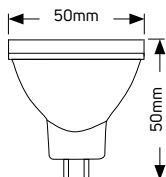

MR16 6W, 36°



CODE	WATT	CCT	BASE	LUMEN	
LHMW5.36E	6	3000	GU5.3	470	1/10/50
LHMC5.36E	6	4000	GU5.3	470	1/10/50

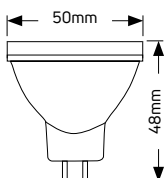

LED G4 1.6W



CODE	WATT	CCT	BASE	LUMEN	
LWG416	1.6	3000	G4	160	1/5/200
LCG416	1.6	4000	G4	170	1/5/200
LWG42-12/24D Dimmable	2	3000	G4	180	1/10/200

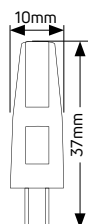

LED G9 Glass 2.5W



CODE	WATT	CCT	BASE	LUMEN	
LWG92.5-G	2.5	3000	G9	230	1/10/100
LCG92.5-G	2.5	4000	G9	240	1/10/100

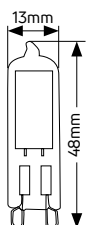

LED G9 Glass 3.5W



CODE	WATT	CCT	BASE	LUMEN	
LG93.5GW	3.5	3000	G9	470	1/10/200
LG93.5GC	3.5	4000	G9	470	1/10/200

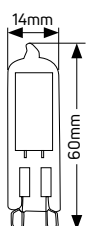

LED G9 3.5W



CODE	WATT	CCT	BASE	LUMEN	
LG93.5-PW	3.5	3000	G9	350	1/10/200
LG93.5-PC	3.5	4000	G9	350	1/10/200
LG93.5WD Dimmable	3.5	3000	G9	350	1/10/200
LG93.5CD Dimmable	3.5	4000	G9	350	1/10/200

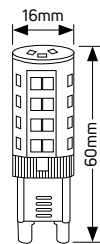

LED G9 5W



CODE	WATT	CCT	BASE	LUMEN	
LG95-PW	5	3000	G9	470	1/10/200
LG95-PC	5	4000	G9	470	1/10/200

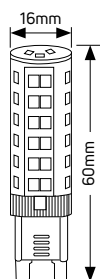

LED Special Lamps

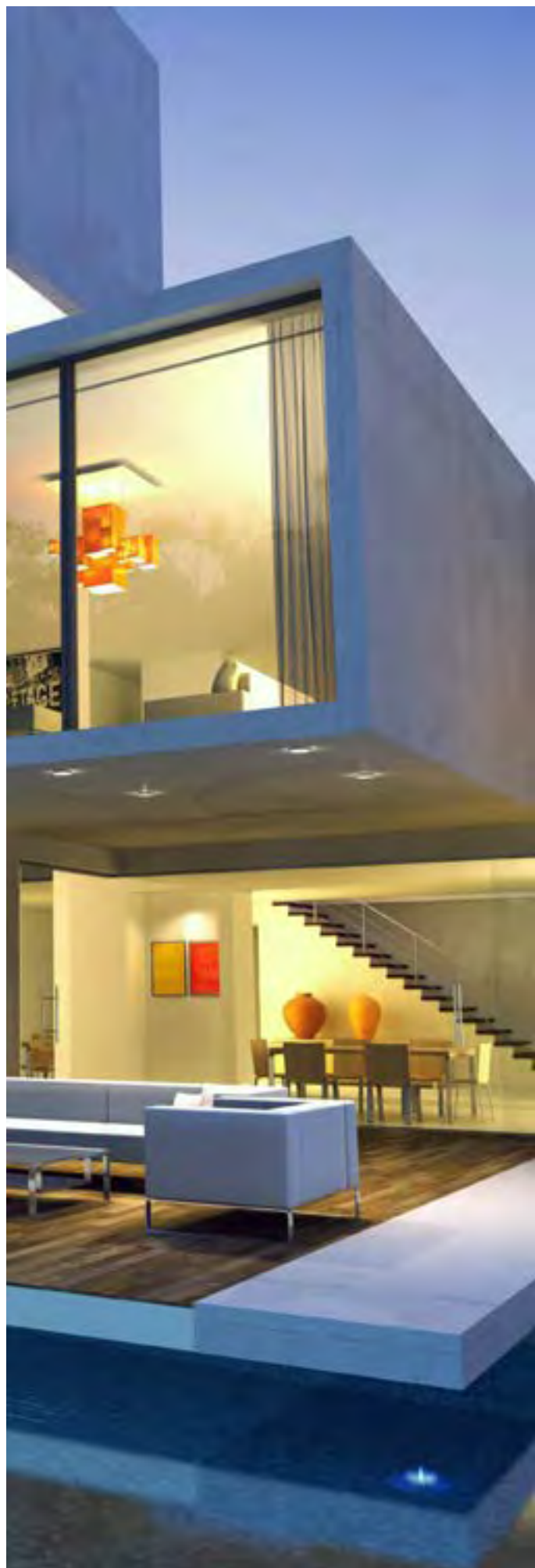

LED R50 5W



CODE	WATT	CCT	BASE	LUMEN	
LKWE145E	5	3000	E14	470	1/5/100
LKCE145E	5	4000	E14	470	1/5/100

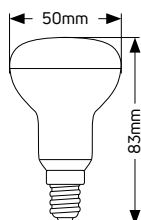

LED R63 8W



CODE	WATT	CCT	BASE	LUMEN	
LKWE278E	8	3000	E27	806	1/5/100
LKCE278E	8	4000	E27	806	1/5/100

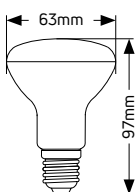

LED R80 12W



CODE	WATT	CCT	BASE	LUMEN	
LK80WE2712	12	3000	E27	1050	1/10/50
LK80CE2712	12	4000	E27	1050	1/10/50

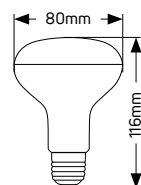

LED PAR20 7W



CODE	WATT	CCT	BASE	LUMEN	
LP20WE277	7	3000	E27	560	1/10/50
LP20CE277	7	4000	E27	560	1/10/50

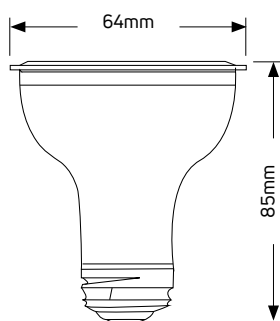

LED PAR30 11W



CODE	WATT	CCT	BASE	LUMEN	
LP30WE2711	11	3000	E27	1000	1/10/50
LP30CE2711	11	4000	E27	1000	1/10/50

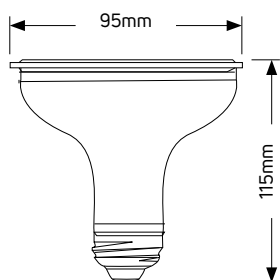

LED PAR38 15W



CODE	WATT	CCT	BASE	LUMEN	
LP38WE2715	15	3000	E27	1100	1/5/20
LP38CE2715	15	4000	E27	1150	1/5/20
LP38DE2715	15	6500	E27	1150	1/5/20
LP38YE2715	15	●	E27	-	1/5/20
LP38GE2715	15	●	E27	-	1/5/20

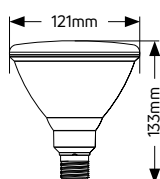

LED PAR38 12-42V AC/DC



CODE	WATT	CCT	BASE	VOLT	LUMEN	
LP38WE2715-12/24	15	3000	E27	12-24V	1100	1/5/20
LP38WE2715-42	15	3000	E27	42V	1100	1/5/20
LP38GE2715-42	15	●	E27	42V	-	1/5/20

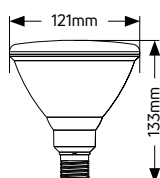

LED PAR56 18W



CODE	WATT	CCT	BASE	LUMEN	
LP56W18	18	3000	GX53	1700	1/5
LP56D18	18	6500	GX53	1800	1/5
LP56RGB18*	18	RGB	GX53		1/5

* RGB remote control Included

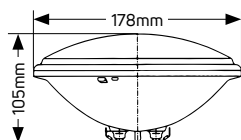

LED AR111 GU10 12W



CODE	WATT	CCT	BEAM ANGLE	BASE	LUMEN	
L111-GU10-24W	12	3000	24°	GU10	900	1/5/20
L111-GU10-24C	12	4000	24°	GU10	900	1/5/20
L111-GU10-45W	12	3000	45°	GU10	850	1/5/20
L111-GU10-45C	12	4000	45°	GU10	870	1/5/20
L111-GU10-24WD Dimmable	12	3000	24°	GU10	900	1/5/20
L111-GU10-45WD Dimmable	12	3000	45°	GU10	850	1/5/20

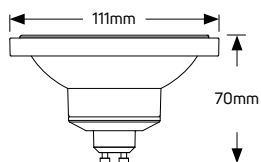

LED AR111 G53 12W



CODE	WATT	CCT	BEAM ANGLE	BASE	LUMEN	
L111-G53-24W	12	3000	24°	G53	900	1/5/20
L111-G53-24C	12	4000	24°	G53	900	1/5/20
L111-G53-45W	12	3000	45°	G53	850	1/5/20
L111-G53-45C	12	4000	45°	G53	870	1/5/20

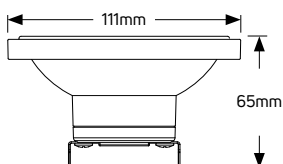



LED Anti Insect



CODE	WATT	CCT	BASE	
LGLYE275	5	●	E27	1/10/50

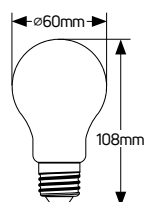

LED R7s 78mm 5W



CODE	WATT	CCT	BASE	LUMEN	
LR7-78WS	5	3000	R7s	450	1/10/200
LR7-78DS	5	6500	R7s	550	1/10/200

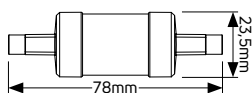

LED R7s 118mm 9W



CODE	WATT	CCT	BASE	LUMEN	
LR7-118WS	9	3000	R7s	800	1/10/50
LR7-118DS	9	6500	R7s	900	1/10/50

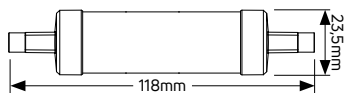

LED Street Lamps



A70 14W



CODE	WATT	CCT	BASE	LUMEN	DIMENSIONS (mm)		
					A	B	
LA70WE2714	14	2700	E27	1500	70	128	1/10/50
LA70CE2714	14	4000	E27	1500	70	128	1/10/50
LA70DE2714	14	6500	E27	1500	70	128	1/10/50

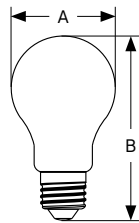

Tubular 15W



CODE	WATT	CCT	BASE	LUMEN	DIMENSIONS (mm)		
					A	B	
LTUW	15	2700	E27	1500	64,5	149	1/10/50
LTUC	15	4000	E27	1550	64,5	149	1/10/50
LTUD	15	6500	E27	1600	64,5	149	1/10/50

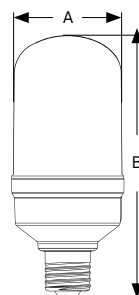

X-LED Corn



CODE	LUMEN	WATT	DIMENSIONS (mm)	
			W	H
LHP.TKC.020.xx	1800	15	70	175
LHP.TKC.025.xx	2500	21	70	195
LHP.TKC.030.xx	3200	27	70	195
LHP.TKC.045.xx	4300	36	93	220
LHP.TKC.055.xx	5400	45	93	245
LHP.TKC.065.xx	6500	54	93	270
LHP.TKC.095.xx	9600	80	120	315
LHP.TKC.120.xx	12000	100	120	335
LHP.TKC.145.xx	14500	120	120	355

*xx=30 for 3000K xx=40 for 4000K xx=50 for 5000K

X-LED Tulip



CODE	LUMEN	WATT	DIMENSIONS (mm)	
			W	H
LHP.TKT.012.xx	1200	10	70	195
LHP.TKT.025.xx	2400	20	70	195
LHP.TKT.035.xx	3600	30	93	267
LHP.TKT.050.xx	4800	40	93	267
LHP.TKT.060.xx	6000	50	93	267
LHP.TKT.100.xx	9600	80	133	300

*xx=30 for 3000K xx=40 for 4000K xx=50 for 5000K

LED Tubes



LED T8 ECO 0.6m



CODE	LENGTH	WATT	CCT	BASE	LUMEN	
LHT8W60ECO	600	9	3000	G13	850	1/25
LHT8C60ECO	600	9	4000	G13	850	1/25
LHT8D60ECO	600	9	6500	G13	850	1/25

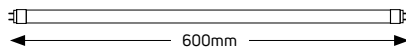

LED T8 ECO 0.9m



CODE	LENGTH	WATT	CCT	BASE	LUMEN	
LHT8W90ECO	900	12	3000	G13	1100	1/25
LHT8C90ECO	900	12	4000	G13	1100	1/25
LHT8D90ECO	900	12	6500	G13	1100	1/25

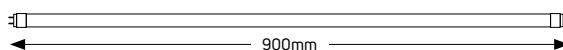

LED T8 ECO 1.2m



CODE	LENGTH	WATT	CCT	BASE	LUMEN	
LHT8W120ECO	1200	18	3000	G13	1700	1/25
LHT8C120ECO	1200	18	4000	G13	1700	1/25
LHT8D120ECO	1200	18	6500	G13	1700	1/25

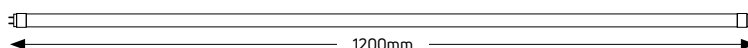

LED T8 ECO 1.5m



CODE	LENGTH	WATT	CCT	BASE	LUMEN	
LHT8W150ECO	1500	21	3000	G13	2050	1/25
LHT8C150ECO	1500	21	4000	G13	2050	1/25
LHT8D150ECO	1500	21	6500	G13	2050	1/25

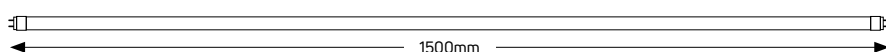

Wiring Connection

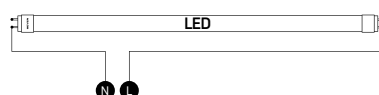

Connect directly to main voltage at one end of each side of the T8 lamp

LED T8 DS 0.6m



CODE	LENGTH	WATT	CCT	BASE	LUMEN	
LHT8W60DS	600	9	3000	G13	900	1/25
LHT8C60DS	600	9	4000	G13	900	1/25
LHT8D60DS	600	9	6500	G13	900	1/25



LED T8 DS 0.9m



CODE	LENGTH	WATT	CCT	BASE	LUMEN	
LHT8W90DS	900	15	3000	G13	1500	1/25
LHT8C90DS	900	15	4000	G13	1500	1/25
LHT8D90DS	900	15	6500	G13	1500	1/25

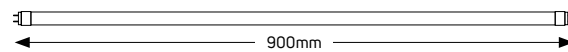

LED T8 DS 1.2m



CODE	LENGTH	WATT	CCT	BASE	LUMEN	
LHT8W120DS	1200	18	3000	G13	1900	1/25
LHT8C120DS	1200	18	4000	G13	1900	1/25
LHT8D120DS	1200	18	6500	G13	1900	1/25

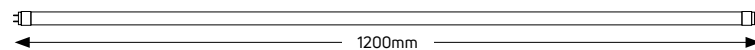

LED T8 DS 1.5m



CODE	LENGTH	WATT	CCT	BASE	LUMEN	
LHT8W150DS	1500	22	3000	G13	2200	1/25
LHT8C150DS	1500	22	4000	G13	2200	1/25
LHT8D150DS	1500	22	6500	G13	2200	1/25

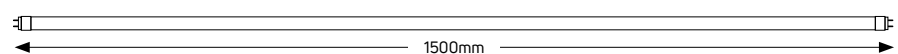

Wiring Connection

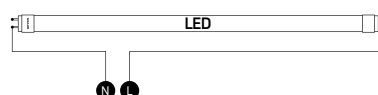

Connect directly to main voltage at one end of each side of the T8 lamp

LED T8 ST 0.6m Starter



CODE	LENGTH	WATT	CCT	BASE	LUMEN	
LHT8W60ST	600	8	3000	G13	900	1/25
LHT8C60ST	600	8	4000	G13	900	1/25
LHT8D60ST	600	8	6500	G13	900	1/25

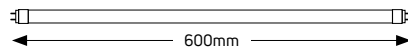

LED T8 ST 0.9m Starter



CODE	LENGTH	WATT	CCT	BASE	LUMEN	
LHT8W90ST	900	12	3000	G13	1200	1/25
LHT8C90ST	900	12	4000	G13	1200	1/25
LHT8D90ST	900	12	6500	G13	1200	1/25

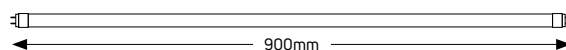

LED T8 ST 1.2m Starter



CODE	LENGTH	WATT	CCT	BASE	LUMEN	
LHT8W120ST	1200	17	3000	G13	1800	1/25
LHT8C120ST	1200	17	4000	G13	1800	1/25
LHT8D120ST	1200	17	6500	G13	1800	1/25

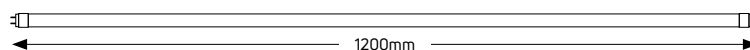

LED T8 ST 1.5m Starter



CODE	LENGTH	WATT	CCT	BASE	LUMEN	
LHT8W150ST	1500	21	3000	G13	2250	1/25
LHT8C150ST	1500	21	4000	G13	2250	1/25
LHT8D150ST	1500	21	6500	G13	2250	1/25

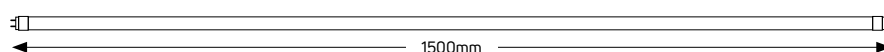

Wiring Connection

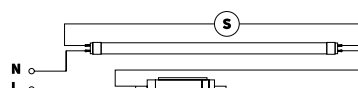

3 installation options

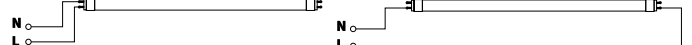

LED T8 ST Meat



CODE	LENGTH	WATT	CCT	BASE	LUMEN	
LHT8M60ST	600	9	3500	G13	700	1/25
LHT8M90ST	900	12	3500	G13	1200	1/25
LHT8M120ST	1200	18	3500	G13	1900	1/25
LHT8M150ST	1500	21	3500	G13	2400	1/25

Wiring Connection

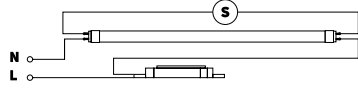

3 installation options

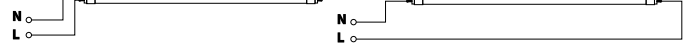

Lamps





LED T8 ST Bread



CODE	LENGTH	WATT	CCT	BASE	LUMEN	
LHT8B60ST	600	9	2200	G13	800	1/25
LHT8B90ST	900	12	2200	G13	1300	1/25
LHT8B120ST	1200	18	2200	G13	1700	1/25
LHT8B150ST	1500	21	2200	G13	2100	1/25

Lamps

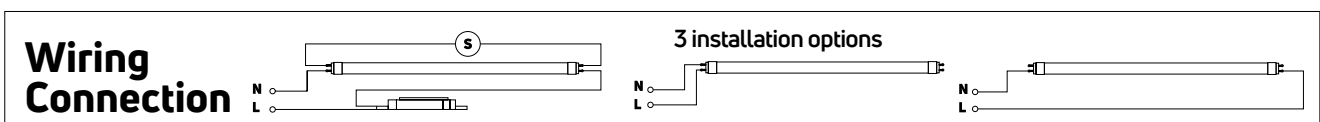



LED T8 ST Vegetables



CODE	LENGTH	WATT	CCT	BASE	LUMEN	
LHT8V60ST	600	9	5500	G13	850	1/25
LHT8V120ST	1200	18	5500	G13	2100	1/25
LHT8V150ST	1500	21	5500	G13	2550	1/25

Lamps

Wiring Connection

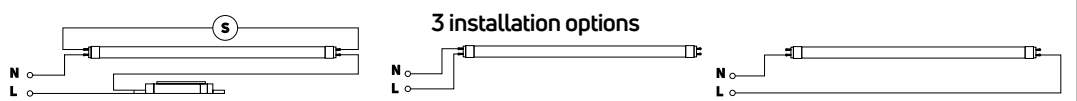

LED T9 Circle



Wiring Connection

Option A

Remove only the starter and keep the magnetic ballast

Option B

Direct connect to 220V using the plug (included in the package)

CODE	WATT	CCT	BASE	LUMEN	
LT9-22D	15	6500	G10Q	1300	1/10
LT9-32D	20	6500	G10Q	1900	1/10
LT9-40D	32	6500	G10Q	2800	1/10

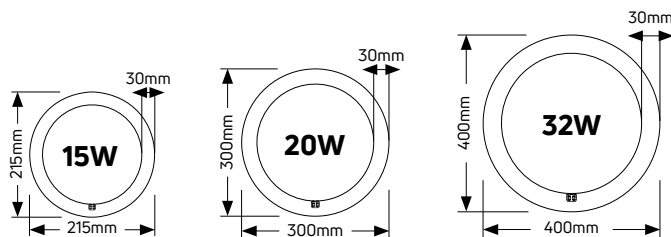

LED Linestra 5W



CODE	WATT	CCT	BASE	LUMEN	
LIN-30W-1	5	3000	S14d	450	1/25
LIN-30W-2	5	3000	S14s	450	1/25



LED Linestra 8W



CODE	WATT	CCT	BASE	LUMEN	
LIN-50W-1	8	3000	S14d	720	1/25
LIN-50W-2	8	3000	S14s	720	1/25

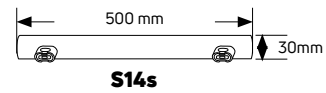
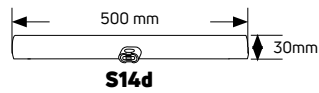

LED Linestra 16W



CODE	WATT	CCT	BASE	LUMEN	
LIN-100W-2	16	3000	S14s	1440	1/25

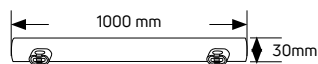

Halogen Lamps





Classic E27



CODE	WATT	CCT	BASE	LUMEN	
FACL2728	28	2700	E27	369	1/10/100
FACL2742	42	2700	E27	623	1/10/100
FACL2753	53	2700	E27	834	1/10/100
FACL2770	70	2700	E27	1180	1/10/100
FACL27100	100	2700	E27	1791	1/10/100



Classic B22



CODE	WATT	CCT	BASE	LUMEN	
FBCL2228	28	2700	B22	369	1/10/100
FBCL2242	42	2700	B22	623	1/10/100
FBCL2253	53	2700	B22	834	1/10/100
FBCL2270	70	2700	B22	1180	1/10/100



Candle



CODE	WATT	CCT	BASE	LUMEN	
FCCL1418	18	2700	E14	209	1/10/100
FCCL1428	28	2700	E14	369	1/10/100
FCCL1442	42	2700	E14	623	1/10/100



Candle Flame



CODE	WATT	CCT	BASE	LUMEN	
FCCL1442FL	42	2700	E14	630	1/10/100



Mini Globe E14



CODE	WATT	CCT	BASE	LUMEN	
FGCL1418	18	2700	E14	209	1/10/100
FGCL1428	28	2700	E14	369	1/10/100
FGCL1442	42	2700	E14	623	1/10/100



Mini Globe E27



CODE	WATT	CCT	BASE	LUMEN	
FGCL2718	18	2700	E27	209	1/10/100
FGCL2728	28	2700	E27	369	1/10/100
FGCL2742	42	2700	E27	623	1/10/100



Globe G125



CODE	WATT	CCT	BASE	LUMEN	
FG12570	70	2700	E27	1180	1/50

GU10 Spot



CODE	WATT	CCT	BASE	LUMEN	
FHG28	28	2700	GU10	370	1/10/100
FHG42	42	2700	GU10	630	1/10/100

MR11 Spot



CODE	WATT	CCT	BASE	LUMEN	
FHMG416	16	2700	GU4	170	1/10/100
FHMG428	28	2700	GU4	370	1/10/100

MR16 Spot



CODE	WATT	CCT	BASE	LUMEN	
FHM16	16	2700	GU5.3	170	1/10/100
FHM28	28	2700	GU5.3	237	1/10/100
FHM40	40	2700	GU5.3	630	1/10/100

G4



CODE	WATT	CCT	BASE	LUMEN	
FG416	16	2700	G4	188	1/100/1000
FG428	28	2700	G4	370	1/100/1000
FGY6.3540	40	2700	GY6.35	630	1/100/1000

G9



CODE	WATT	CCT	BASE	LUMEN	
FG918	18	2700	G9	209	1/100/1000
FG928	28	2700	G9	370	1/100/1000
FG942	42	2700	G9	623	1/100/1000



R50



CODE	WATT	CCT	BASE	LUMEN	
FK1428	28	2700	E14	219	1/10/100
FK1442	42	2700	E14	623	1/10/100



R63



CODE	WATT	CCT	BASE	LUMEN	
FK2728	28	2700	E27	219	1/10/100
FK2742	42	2700	E27	375	1/10/100
FK2753	53	2700	E27	505	1/10/100



R80



CODE	WATT	CCT	BASE	LUMEN	
F80K2770	70	2700	E27	1180	1/5/50

R7s 78mm



CODE	WATT	CCT	BASE	LUMEN	
FR77880	80	2700	R7s	1380	1/50/500
FR778120	120	2700	R7s	2200	1/50/500

R7s 118mm



CODE	WATT	CCT	BASE	LUMEN	
FR7118160	160	2700	R7s	3100	1/50/500
FR7118230	230	2700	R7s	4700	1/50/500
FR7118400	400	2700	R7s	8550	1/50/500

T22 Oven Lamp



CODE	WATT	CCT	BASE	LUMEN	
HOL	15	2700	E14	88	1/10/500

Conversion Lamp Holders





CODE	DESCRIPTION	
ADE27E14	E27 to E14	1/20



CODE	DESCRIPTION	
ADE27E27	E27 to E27	1/20



CODE	DESCRIPTION	
ADE272E27	E27 to 2xE27	1/20



CODE	DESCRIPTION	
ADE27GU10	E27 to GU10	1/20



CODE	DESCRIPTION	
ADE14E27	E14 to E27	1/20



CODE	DESCRIPTION	
ADE14GU10	E14 to GU10	1/20



CODE	DESCRIPTION	
ADE40E27	E40 to E27	1/20



CODE	DESCRIPTION	
ADB22E27	B22 to E27	1/20



CODE	DESCRIPTION	
ADGU10E27	GU10 to E27	1/20



CODE	DESCRIPTION	
ADG9E14	G9 to E14	1/20

Fluorescent Lamps





T8 Lamp 18W



CODE	WATT	CCT	BASE	LUMEN	
HT8CW60	18	4000	G13	1110	1/25
HT8CE60	18	6500	G13	960	1/25



T8 Lamp 30W



CODE	WATT	CCT	BASE	LUMEN	
HT8CW90	30	4000	G13	2020	1/25
HT8CE90	30	6500	G13	1720	1/25



T8 Lamp 36W



CODE	WATT	CCT	BASE	LUMEN	
HT8CW120	36	4000	G13	2650	1/25
HT8CE120	36	6500	G13	2400	1/25



T8 Lamp 58W



CODE	WATT	CCT	BASE	LUMEN	
HT8CW150	58	4000	G13	4780	1/25
HT8CE150	58	6500	G13	4080	1/25

T9 CIRCLE Lamp



CODE	WATT	CCT	BASE	LUMEN	
HLCCR22	22	6500	G10Q	1050	1/20
HLCCR32	32	6500	G10Q	1700	1/10
HLCCR40	40	6500	G10Q	2500	1/10

T8, T9 Starter

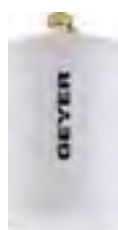

CODE	WATT	
FST2	4-22	25/1000
FST10	4-65	25/1000

Fluorescent UV-A Lamps



T5 UV-A Lamp BL 365 4W



CODE	WATT	BASE	Nm	
HT5UVA4	4	G5	365	1/25

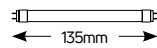

T5 UV-A Lamp BL 365 6W



CODE	WATT	BASE	Nm	
HT5UVA6	6	G5	365	1/25

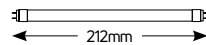

T5 UV-A Lamp BL 365 8W



CODE	WATT	BASE	Nm	
HT5UVA8	8	G5	365	1/25

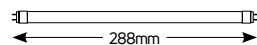

T5 UV-A Lamp BL 365 13W



CODE	WATT	BASE	Nm	
HT5UVA13	13	G5	365	1/25

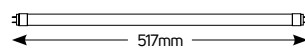

T8 UV-A Lamp BL 365 10W



CODE	WATT	BASE	Nm	
HT8UVA10	10	G13	365	1/25

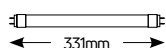

T8 UV-A Lamp BL 365 15W



CODE	WATT	BASE	Nm	
HT8UVA15	15	G13	365	1/25

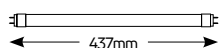

T8 UV-A Lamp BL 365 18W



CODE	WATT	BASE	Nm	
HT8UVA18	18	G13	365	1/25

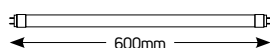

T8 UV-A Lamp BL 365 30W



CODE	WATT	BASE	Nm	
HT8UVA30	30	G13	365	1/25

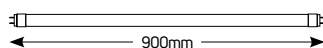

T8 UV-A Lamp BL 365 36W



CODE	WATT	BASE	Nm	
HT8UVA36	36	G13	365	1/25

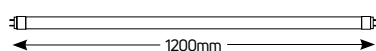

Fluorescent Blacklight Lamps

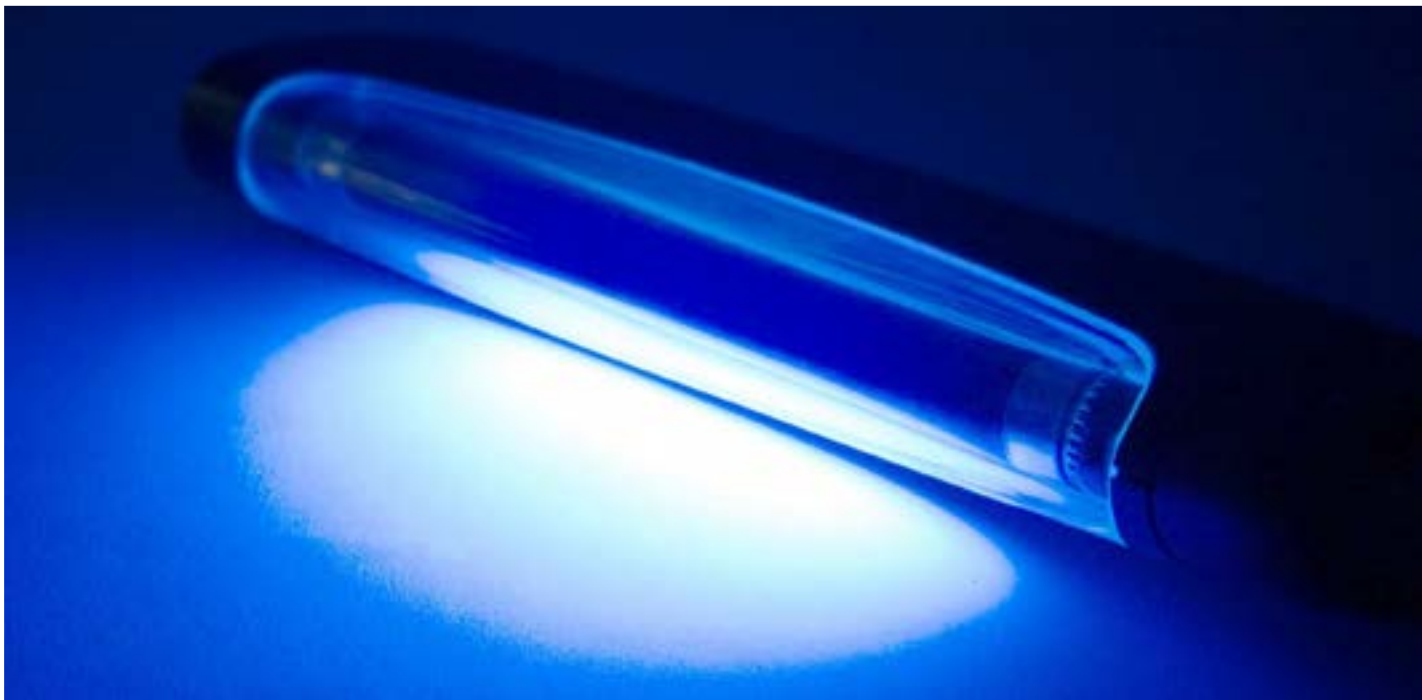

T5 BLB Blacklight Lamp 4W



CODE	WATT	BASE	Nm	
HT5BLB4	4	G5	365	1/25

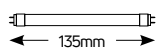

T5 BLB Blacklight Lamp 6W



CODE	WATT	BASE	Nm	
HT5BLB6	6	G5	365	1/25

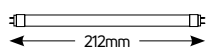

T5 BLB Blacklight Lamp 8W



CODE	WATT	BASE	Nm	
HT5BLB8	8	G5	365	1/25

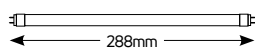

T5 BLB Blacklight Lamp 13W



CODE	WATT	BASE	Nm	
HT5BLB13	13	G5	365	1/25

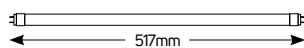

T8 BLB Blacklight Lamp 10W



CODE	WATT	BASE	Nm	
HT8BLB10	10	G13	365	1/25

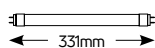

T8 BLB Blacklight Lamp 15W



CODE	WATT	BASE	Nm	
HT8BLB15	15	G13	365	1/25

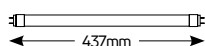

T8 BLB Blacklight Lamp 18W



CODE	WATT	BASE	Nm	
HT8BLB18	18	G13	365	1/25

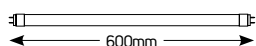

T8 BLB Blacklight Lamp 36W



CODE	WATT	BASE	Nm	
HT8BLB36	36	G13	365	1/25

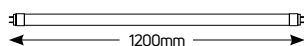

Fluorescent Germicidal UV-C Lamps



T5 UV-C Germicidal Lamp 6W



CODE	WATT	BASE	Nm	
HT5UVC6	6	G5	254	1/25

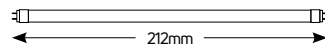

T5 UV-C Germicidal Lamp 8W



CODE	WATT	BASE	Nm	
HT5UVC8	8	G5	254	1/25

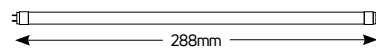

T8 UV-C Germicidal Lamp 15W



CODE	WATT	BASE	Nm	
HT8UVC15	15	G13	254	1/25

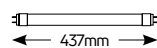

T8 UV-C Germicidal Lamp 18W



CODE	WATT	BASE	Nm	
HT8UVC18	18	G13	254	1/25

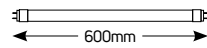

T8 UV-C Germicidal Lamp 30W



CODE	WATT	BASE	Nm	
HT8UVC30	30	G13	254	1/25

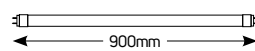

T8 UV-C Germicidal Lamp 36W



CODE	WATT	BASE	Nm	
HT8UVC36	36	G13	254	1/25

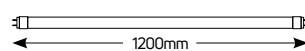



High Pressure Lamps

Metal Halide MHL-E



CODE	TYPE	WATT	CCT	BASE	LUMEN	
MHLE.060.40	M.H.L 70W	70	4000	E27	5800	1/40
MHLE.130.40	M.H.L 150W	150	4000	E27	13000	1/40
MHLE.220.40	M.H.L 250W	250	4000	E40	22000	1/20
MHLE.420.40	M.H.L 400W	400	4000	E40	42000	1/10

Metal Halide MHL-T



CODE	TYPE	WATT	CCT	BASE	LUMEN	
MHLT.060.40	M.H.L 70W	70	4000	E27	5800	1/40
MHLT.130.40	M.H.L 150W	150	4000	E27	13000	1/40
MHLT.130.40.E4	M.H.L 150W	150	4000	E40	13000	1/40
MHLT.220.40	M.H.L 250W	250	4000	E40	22000	1/40
MHLT.420.40	M.H.L 400W	400	4000	E40	42000	1/40
MHLT.1100.40	M.H.L 1000W	1000	4000	E40	110000	1/40

Metal Halide RX7s



CODE	TYPE	WATT	CCT	BASE	LUMEN	
MHLRX7.070.30	M.H.L 70W	70	3000	RX7	6000	10/100
MHLRX7.070.40	M.H.L 150W	70	4200	RX7	6000	10/100
MHLRX7.150.30	M.H.L 250W	150	3000	RX7	13000	10/100
MHLRX7.150.40	M.H.L 400W	150	4200	RX7	13000	10/100

High Pressure Sodium HPS-E



CODE	TYPE	WATT	CCT	BASE	LUMEN	
HPS.E.060.20	H.P.S.L 70W	70	2000	E27	6000	1/40
HPS.E.155.20	H.P.S.L 150W	150	2000	E40	15600	1/20
HPS.E.270.20	H.P.S.L 250W	250	2000	E40	27000	1/20
HPS.E.480.20	H.P.S.L 400W	400	2000	E40	48000	1/10

High Pressure Sodium HPS-T



CODE	TYPE	WATT	CCT	BASE	LUMEN	
HPS.T.060.20	H.P.S.L 70W	70	2000	E27	6000	1/40
HPS.T.155.20	H.P.S.L 150W	150	2000	E40	15600	1/40
HPS.T.270.20	H.P.S.L 250W	250	2000	E40	27000	1/40
HPS.T.480.20	H.P.S.L 400W	400	2000	E40	48000	1/40

CHAPTER B

Architectural
Illumination



Downlights

3W



CODE	WATT	CCT	LUMEN	
LPLW3S	3	3000	180	1/40
LPLC3S	3	4000	180	1/40
LPLD3S	3	6500	180	1/40

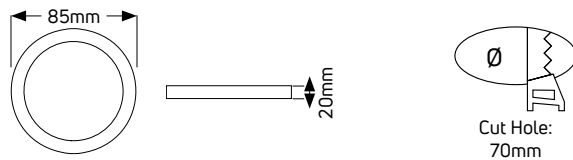

6W



CODE	WATT	CCT	LUMEN	
LPLW6S	6	3000	380	1/40
LPLC6S	6	4000	380	1/40
LPLD6S	6	6500	380	1/40

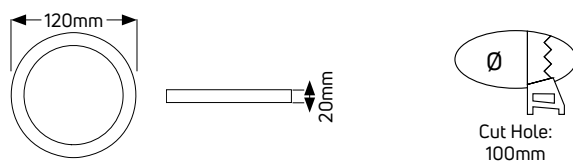

9W



CODE	WATT	CCT	LUMEN	
LPLW9S	9	3000	650	1/40
LPLC9S	9	4000	650	1/40
LPLD9S	9	6500	650	1/40

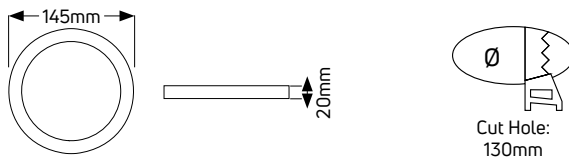

12W



CODE	WATT	CCT	LUMEN	
LPLW12S	12	3000	900	1/20
LPLC12S	12	4000	900	1/20
LPLD12S	12	6500	900	1/20

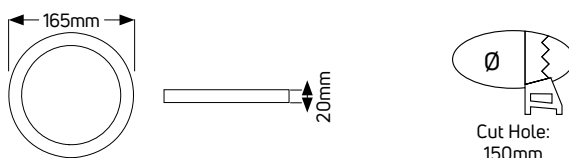



18W



CODE	COLOR BODY	WATT	CCT	LUMEN	
LPLW18S	○	18	3000	1550	1/20
LPLC18S	○	18	4000	1550	1/20
LPLD18S	○	18	6500	1550	1/20
LPLW18G	●	18	3000	1550	1/20
LPLC18G	●	18	4000	1550	1/20
LPLD18G	●	18	6500	1550	1/20

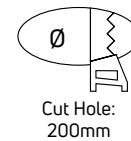
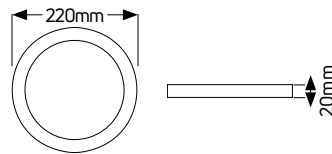

18W



CODE	WATT	CCT	LUMEN	
LPLW18TS	18	3000	1550	1/20
LPLC18TS	18	4000	1550	1/20
LPLD18TS	18	6500	1550	1/20

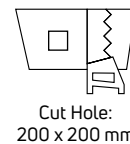
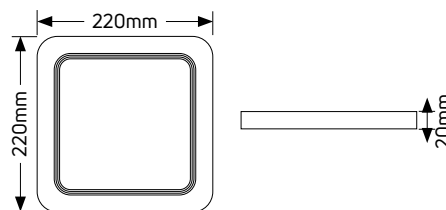

24W



CODE	WATT	CCT	LUMEN	
LPLW24S	24	3000	2100	1/20
LPLC24S	24	4000	2100	1/20
LPLD24S	24	6500	2100	1/20

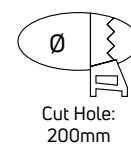
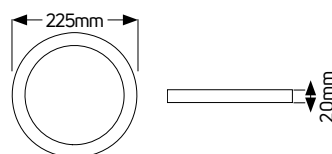

Surface mounted downlights

YEARS
3
WARRANTY



- 78°
- IP20
- RA ≥80
- PF>0.5
- ENERGY CLASS A+
- 20.000h
- 20°/+40°

CODE	WATT	CCT	LUMEN	
LPLAW18S	18	3000	1550	1/20
LPLAC18S	18	4000	1550	1/20
LPLAD18S	18	6500	1550	1/20

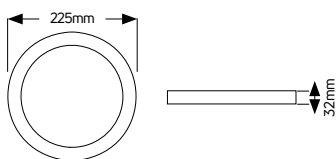

YEARS
3
WARRANTY



- 78°
- IP20
- RA ≥80
- PF>0.9
- ENERGY CLASS A+
- 20.000h
- 20°/+40°

CODE	WATT	CCT	LUMEN	
LPLAW18TS	18	3000	1550	1/20
LPLAC18TS	18	4000	1550	1/20
LPLAD18TS	18	6500	1550	1/20

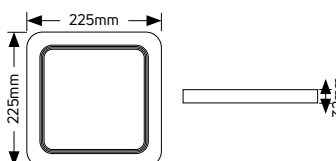

YEARS
3
WARRANTY



● Μαύρο

- 72°
- IP40
- CRI80
- CLASS I
- 100-277VAC
- PF>0.9
- ENERGY CLASS A+
- 40.000h
- 20°/+45°

CODE	WATT	CCT	LUMEN	
LCBW3025W	25	3000	1850	1/4
LCBW4035W	35	3000	2920	1/4



Downlights

GEYER



CODE	WATT	CCT	LUMEN	
LDLW751060W	10	3000	870	1/50
LDLC751060W	10	4000	1000	1/50

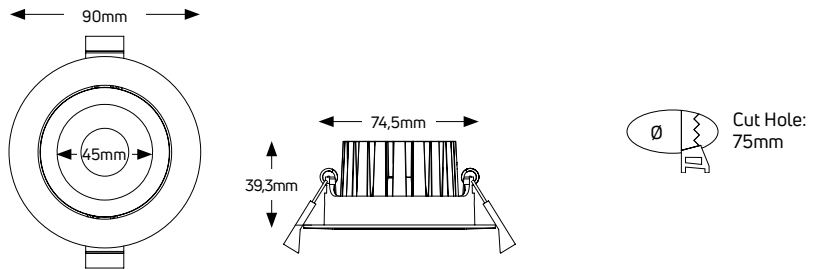

CODE	WATT	CCT	LUMEN	
LDLW16535S60W	35	3000	3570	1/12
LDLC16535S60W	35	4000	3800	1/12

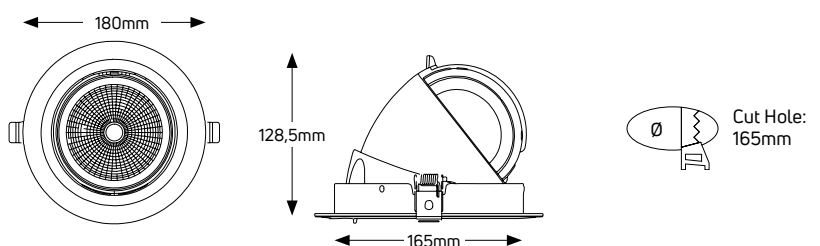

Architectural Illumination



Downlights

YEARS
5
WARRANTY



CODE	WATT	CCT	LUMEN	
LDLW901360W	13	3000	1040	1/30
LDLC901360W	13	4000	1090	1/30

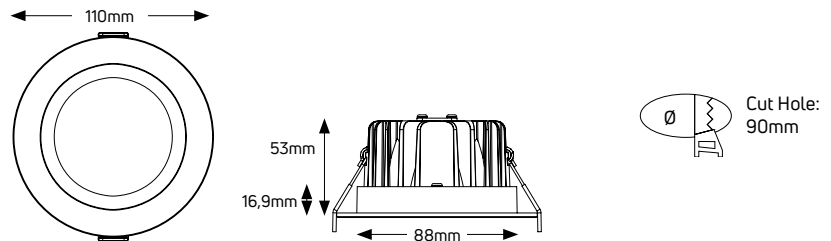

YEARS
5
WARRANTY



CODE	WATT	BEAM ANGLE	CCT	LUMEN	
LDLW1201824W	18	24	3000	1980	1/12
LDLW1201845W	18	45	3000	1980	1/12
LDLW1201860W	18	60	3000	1980	1/12
LDLC1201824W	18	24	4000	2070	1/12
LDLC1201845W	18	45	4000	2070	1/12
LDLC1201860W	18	60	4000	2070	1/12

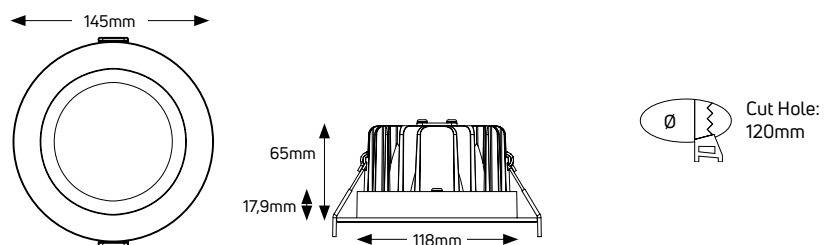

YEARS
5
WARRANTY



CODE	WATT	BEAM ANGLE	CCT	LUMEN	
LDLW1602536W	25	36	3000	2700	1/12
LDLW1602560W	25	60	3000	2700	1/12
LDLC1602536W	25	36	4000	2825	1/12
LDLC1602560W	25	60	4000	2825	1/12

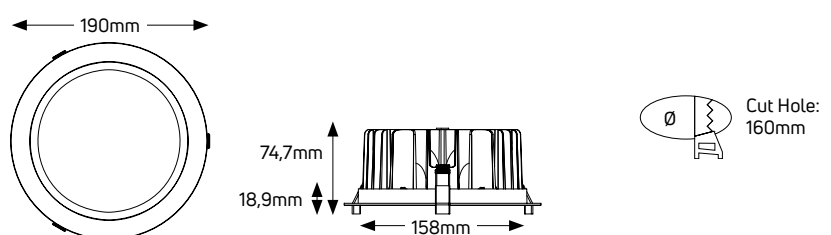

Downlights

GEYER

YEARS
5
WARRANTY



CODE	WATT	BEAM ANGLE	CCT	LUMEN	
LDLW2003524W	35	24	3000	3605	1/12
LDLW2003536W	35	36	3000	3605	1/12
LDLW2003560W	35	60	3000	3605	1/12
LDLC2003524W	35	24	4000	3885	1/12
LDLC2003536W	35	36	4000	3885	1/12
LDLC2003560W	35	60	4000	3885	1/12

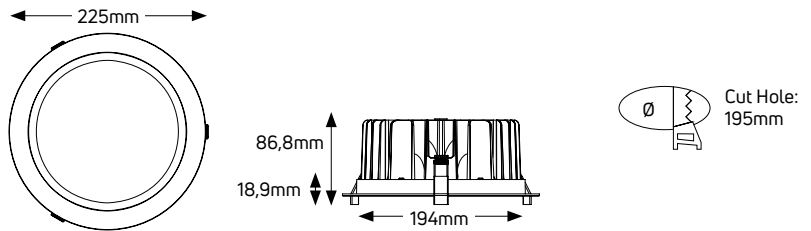

Architectural Illumination

YEARS
5
WARRANTY



CODE	WATT	BEAM ANGLE	CCT	LUMEN	
LDLW2004524W	45	24	3000	4410	1/12
LDLW2004536W	45	36	3000	4410	1/12
LDLW2004560W	45	60	3000	4410	1/12
LDLC2004524W	45	24	4000	4725	1/12
LDLC2004536W	45	36	4000	4725	1/12
LDLC2004560W	45	60	4000	4725	1/12

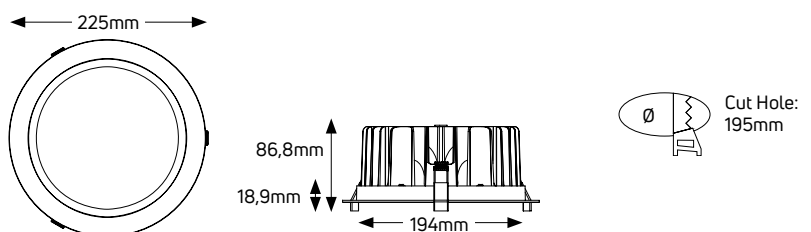

LED Panels



Panel Sandwich 60x60



CODE	WATT	CCT	LUMEN	
LP40UW	40	3000	2950	1/4
LP40UC	40	4000	3150	1/4
LP40UD	40	6500	3150	1/4

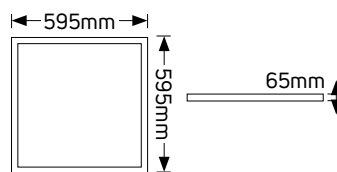

Panel Eco 60x60



CODE	WATT	CCT	LUMEN	
LP40BLW	40	3000	4000	1/6
LP40BLC	40	4000	4000	1/6
LP40BLD	40	6500	4000	1/6
LP60FR	Surface frame			1/20
LP40-K	Hanging tool 2.5m			1/100
LP40-SP4	Kit for plasterboard			1/100

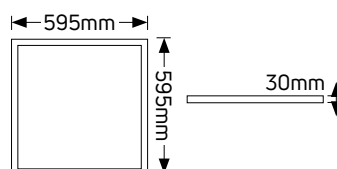

Panel Slim 60x60



CODE	WATT	CCT	LUMEN	
LP40W5	40	3000	3600	1/5
LP40C5	40	4000	3800	1/5
LP40D5	40	6500	3800	1/5
LF-GDE042YF	Driver 0-10V Lifud			1/1
LF-GDE042YFS	Driver Dali Lifud			1/16
LP60-ARW	Surface frame			1/20
LP40-K	Hanging tool 2.5m			1/100
LP40-SP4	Kit for plasterboard			1/100

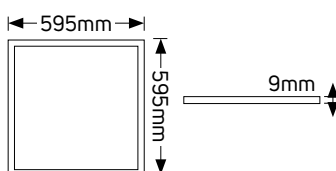

Panel Slim 60x60 UGR<19



CODE	WATT	CCT	LUMEN	
LP40W5.UGR	40	3000	3600	1/5
LP40C5.UGR	40	4000	3800	1/5
LP40D5.UGR	40	6500	3800	1/5
LF-GDE042YF	Driver 0-10V Lifud			1/1
LF-GDE042YFS	Driver Dali Lifud			1/16
LP60-ARW	Surface frame			1/20
LP40-K	Hanging tool 2.5m			1/100
LP40-SP4	Kit for plasterboard			1/100

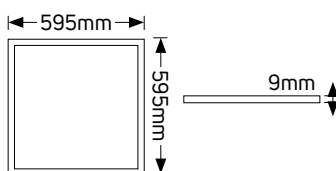

Panel Avra 60x60 UGR<19



CODE	WATT	CCT	LUMEN	
LP40BLW5.UGR	40	3000	4000	1/5
LP40BLC5.UGR	40	4000	4000	1/5
LP40BLD5.UGR	40	6500	4000	1/5
LF-GDE042YF	Driver 0-10V Lifud			1/16
LF-GDE042YFS	Driver Dali Lifud			1/16
LP60FR	Surface frame			1/20
LP40-K	Hanging tool 2.5m			1/100
LP40-SP4	Kit for plasterboard			1/100

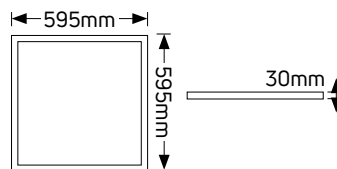

Panel Lithos 60x60 UGR<19



CODE	WATT	CCT	LUMEN	
LP66G44W	40	3000	4400	1/6
LP66G44C	40	4000	4400	1/6
LP66G66W	60	3000	6600	1/6
LP66G66C	60	4000	6600	1/6
LP60FR	Surface frame			1/20
LP40-K	Hanging tool 2.5m			1/100
LP40-SP4	Kit for plasterboard			1/100

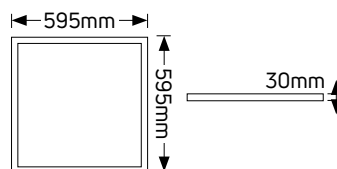

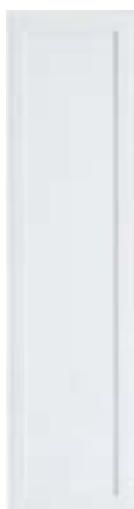

Panel Eco 120x30



CODE	WATT	CCT	LUMEN	
LP13BLW	40	3000	4000	1/5
LP13BLC	40	4000	4000	1/5
LP13BLD	40	6500	4000	1/5
LP13FR	Surface frame for Panel Eco 120x30			1/20
LP40-K	Hanging tool for Panels, 6pcs., 2.5m			1/100
LP120-SP8	Kit for holewall mounting Panel, 8pcs.			1/100

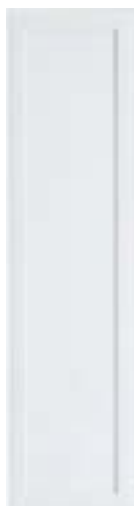
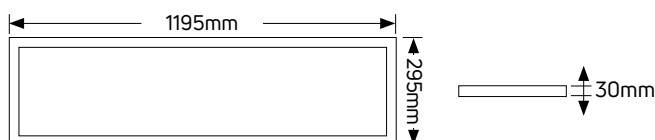

Panel Slim 120x30



CODE	WATT	CCT	LUMEN	
LP120-30W5	40	3000	3600	1/5
LP120-30C5	40	4000	3800	1/5
LP120-30D5	40	6500	3800	1/5
LF-GDE042YF	Driver 0-10V Lifud			1/16
LF-GDE042YFS	Driver Dali Lifud			1/16
LP120-30ARW	Surface frame			1/20
LP40-K	Hanging tool 2.5m			1/100
LP120-SP8	Kit for plasterboard			1/100

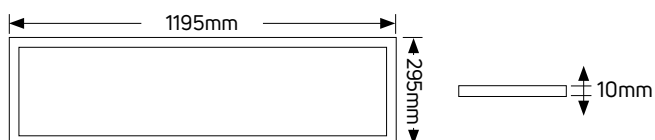

Panel Slim 120x30 UGR<19

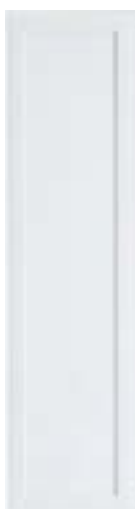

CODE	WATT	CCT	LUMEN	
LP120-30W5.UGR	40	3000	3600	1/5
LP120-30C5.UGR	40	4000	3800	1/5
LP120-30D5.UGR	40	6500	3800	1/5
LF-GDE042YF	Driver 0-10V Lifud			1/16
LF-GDE042YFS	Driver Dali Lifud			1/16
LP120-30ARW	Surface frame			1/20
LP40-K	Hanging tool 2.5m			1/100
LP120-SP8	Kit for plasterboard			1/100

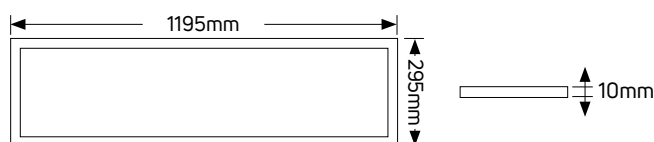

Panel Avra 120x30 UGR<19

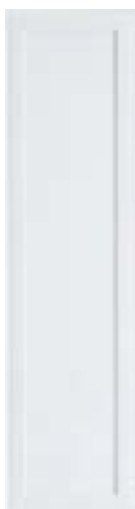

CODE	WATT	CCT	LUMEN	
LP13BLW5.UGR	40	3000	4000	1/5
LP13BLC5.UGR	40	4000	4000	1/5
LP13BLD5.UGR	40	6500	4000	1/5
LF-GDE042YF	Driver 0-10V Lifud			1/16
LF-GDE042YFS	Driver Dali Lifud			1/16
LP13FR	Surface frame			1/20
LP40-K	Hanging tool 2.5m			1/100
LP120-SP8	Kit for plasterboard			1/100

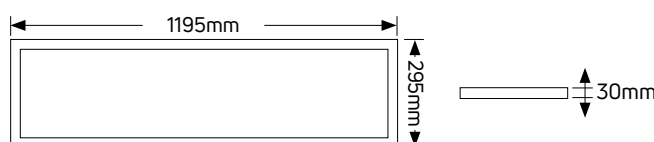

Panel Lithos 120x30 UGR<19



CODE	WATT	CCT	LUMEN	
LP13G44W	40	3000	4400	1/6
LP13G44C	40	4000	4400	1/6
LP13G66W	60	3000	6600	1/6
LP13G66C	60	4000	6600	1/6
LP13FR	Surface frame			1/20
LP40-K	Hanging tool 2.5m			1/100
LP120-SP8	Kit for plasterboard			1/100

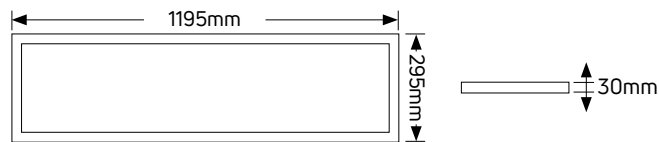

Panel Avra 60x30 UGR<19



CODE	WATT	CCT	LUMEN	
LP63BLW5.UGR	24	3000	2160	1/5
LP63BLC5.UGR	24	4000	2160	1/5
LP63BLD5.UGR	24	6500	2160	1/5
LF-GDE030YFA	Driver 0-10V Lifud			1/16
LF-GDE030YFS	Driver Dali Lifud			1/16
LP63FR	Surface frame			1/20
LP40-K	Hanging tool 2.5m			1/100
LP40-SP4	Kit for plasterboard			1/100

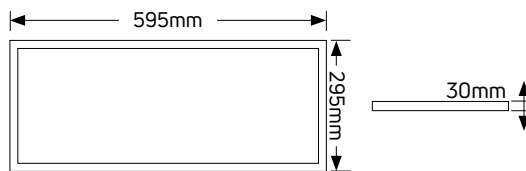

Panel Avra 120x60 UGR<19



CODE	WATT	CCT	LUMEN	
LP16BLW5.UGR	60	3000	6000	1/5
LP16BLC5.UGR	60	4000	6000	1/5
LP16BLD5.UGR	60	6500	6000	1/5
LF-GDE060YFA	Driver 0-10V Lifud			1/16
LF-GDE060YFS	Driver Dali Lifud			1/16
LP16FR	Surface frame			1/20
LP60K	Hanging tool 2.5m			1/100
LP120-SP8	Kit for plasterboard			1/100

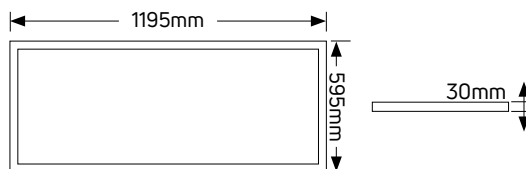





CODE	DESCRIPTION	
LF-GIF040YA	Driver Flicker Free for Panel 40W Lifud	1

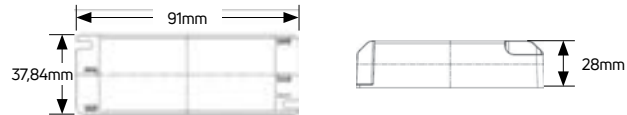

CODE	DESCRIPTION	
LF-GDE042YF	Driver 0-10V for Panel 40W Lifud	1

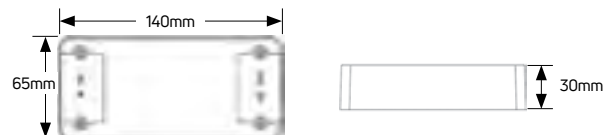

CODE	DESCRIPTION	
LF-GDE042YFS	Driver Dali for Panel 40W Lifud	1

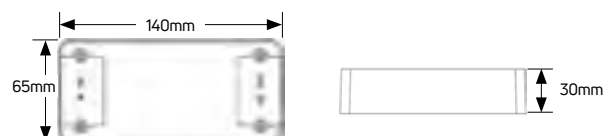



CODE	DESCRIPTION	
LF-GSD040YC	Driver Dali/0-10V/PUSH/PWM for Panel 40W Lifud	1

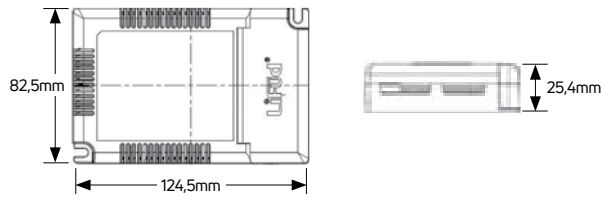

CODE	DESCRIPTION	
LF-GIF030YA	Driver Flicker Free for Panel 24W Lifud	1

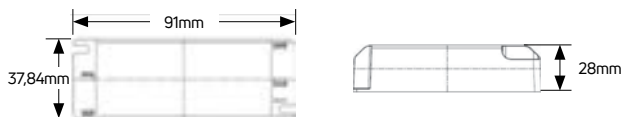

CODE	DESCRIPTION	
LF-GDE030YFA	Driver 0-10V for Panel 24W Lifud	1

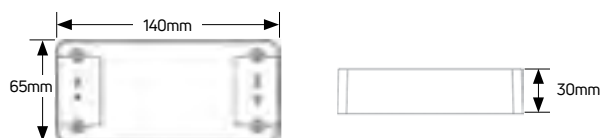

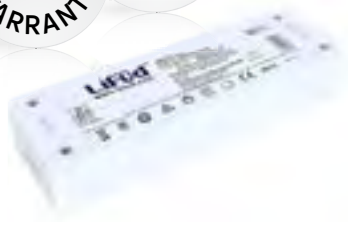

CODE	DESCRIPTION	
LF-GDE030YFS	Driver Dali for Panel 24W Lifud	1

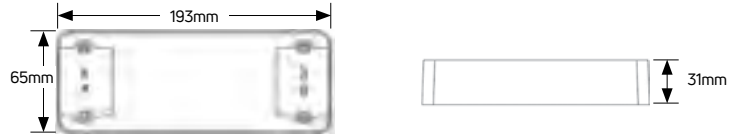

CODE	DESCRIPTION	
LF-GIF060YA	Driver Flicker Free for Panel 60W Lifud	1



CODE	DESCRIPTION	
LF-GDE060YFA	Driver 0-10V for Panel 60W Lifud	1



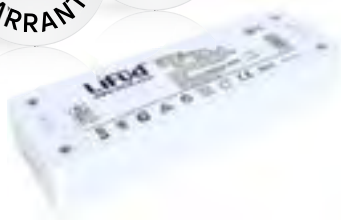

CODE	DESCRIPTION	
LF-GDE060YFS	Driver Dali for Panel 60W	1

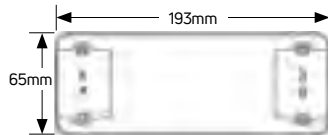

Architectural Illumination

Lighting Fixtures



Fixtures for LED T8 IP20



CODE	BASE	LENGTH	
FT8S0.6-0	G13	1x0.60m	1/60
FT8D0.6-0	G13	2x0.60m	1/60
FT8S1.2-0	G13	1x1.20m	1/60
FT8D1.2-0	G13	2x1.20m	1/60
FT8S1.5-0	G13	1x1.50m	1/60
FT8D1.5-0	G13	2x1.50m	1/60

LED Lighting fixtures IP20



CODE	WATT	CCT	LUMEN	
LBT8-0.6	10	4000	900	1/20
LBT8-1.2	20	4000	1800	1/20
LBT8-1.5	25	4000	2300	1/20

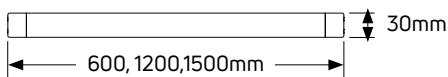

Fixtures for LED T8 60cm IP65



CODE	BASE	LAMPS	
FT8S0.6HP	G13	1x0.6m	1/15
FT8D0.6HP	G13	2x0.6m	1/10



Fixtures for LED T8 1.20m IP65



CODE	BASE	LAMPS	
FT8S1.2HP	G13	1x1.2m	1/15
FT8D1.2HP	G13	2x1.2m	1/10

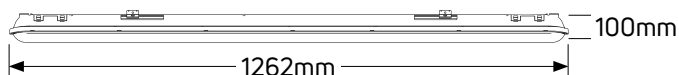

Fixtures for LED T8 1.50m IP65



CODE	BASE	LAMPS	
FT8S1.5HP	G13	1x1.5m	1/15
FT8D1.5HP	G13	2x1.5m	1/10

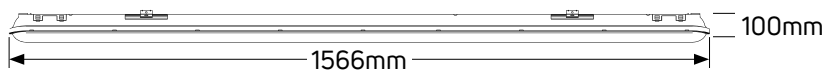

LED Luminaire 60cm IP65

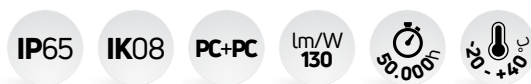

CODE	WATT	CCT	LUMEN	
LT8C0.6S	12	4000	1560	1/20
LT8D0.6S	12	6500	1560	1/20
LT8C0.6D	21	4000	2730	1/20
LT8D0.6D	21	6500	2730	1/20

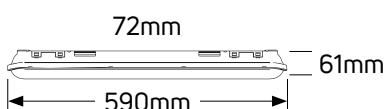

LED Luminaire 1.50cm IP65



CODE	WATT	CCT	LUMEN	
LT8C1.2S	24	4000	3120	1/15
LT8D1.2S	24	6500	3120	1/15
LT8C1.2D	40	4000	5200	1/15
LT8D1.2D	40	6500	5200	1/15

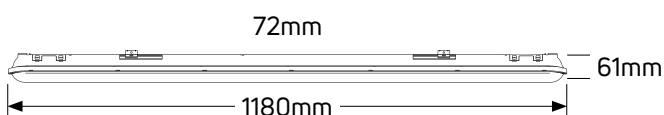

LED Luminaire 1.50m IP65

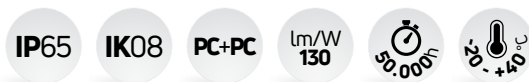

CODE	WATT	CCT	LUMEN	
LT8C1.5S	33	4000	4290	1/12
LT8D1.5S	33	6500	4290	1/12
LT8C1.5D	55	4000	7150	1/12
LT8D1.5D	55	6500	7150	1/12



Architectural Illumination





Cabinet Light 4W



CODE	WATT	CCT	LUMEN	
LWT530	4	3000	340	1/20
LCT530	4	4000	340	1/20
LT5-CC	Extension cable, 15cm			1/1

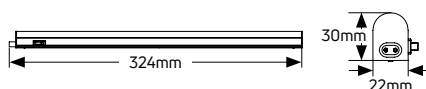

Cabinet Light 8W



CODE	WATT	CCT	LUMEN	
LWT560	8	3000	680	1/20
LCT560	8	4000	680	1/20
LT5-CC	Extension cable, 15cm			1/1

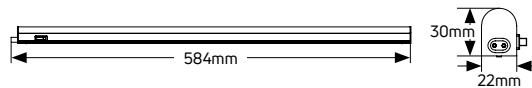

Cabinet Light 10W



CODE	WATT	CCT	LUMEN	
LWT590	10	3000	850	1/20
LCT590	10	4000	850	1/20
LT5-CC	Extension cable, 15cm			1/1

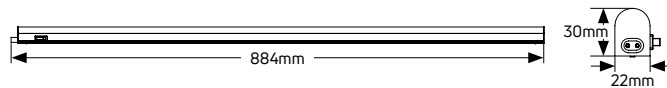

Cabinet Light 14W



CODE	WATT	CCT	LUMEN	
LWT5120	14	3000	1190	1/20
LCT5120	14	4000	1190	1/20
LT5-CC	Extension cable, 15cm			1/1

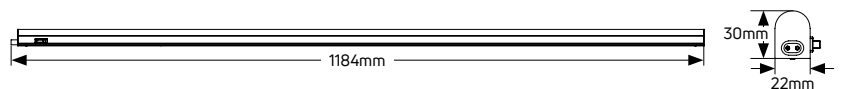

PIR Sensors





CODE	BEAM ANGLE	DETECTION RANGE (m)	SENSITIVITY (lux)	
SIM-S	360°	6	3-2000	1/10

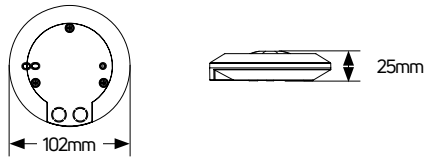

CODE	BEAM ANGLE	DETECTION RANGE (m)	SENSITIVITY (lux)	
SIM-B	180°	5-12	3-2000	1/10

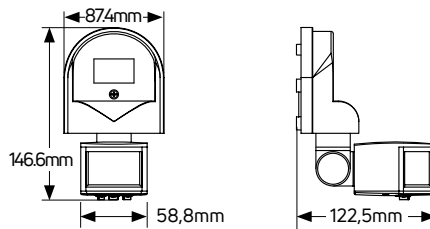

CODE	BEAM ANGLE	DETECTION RANGE (m)	SENSITIVITY (lux)	
SIM-M	180°	12	3-2000	1/10

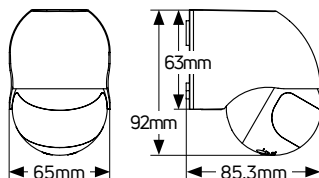

Highbays



YEARS
3
WARRANTY



Highbay Economy 100W



CODE	WATT	CCT	LUMEN	
LHB100RNS	100	5000	10000	1

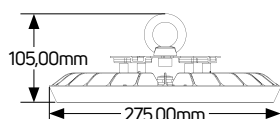

YEARS
3
WARRANTY



Highbay Economy 150W



CODE	WATT	CCT	LUMEN	
LHB150RNS	150	5000	15000	1

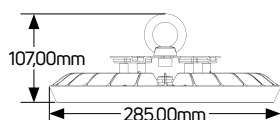

YEARS
3
WARRANTY



Highbay Economy 200W



CODE	WATT	CCT	LUMEN	
LHB200RNS	200	5000	20000	1

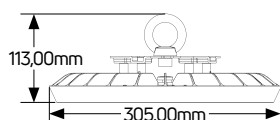

Reflector



CODE	DESCRIPTION	
LHCAPAL	Alu Reflector for Highbay Economy	1
LHCAPPC	PC Reflector for Highbay Economy	1

YEARS
5
WARRANTY



Highbay Premium 60W



CODE	WATT	CCT	LUMEN	BEAM ANGLE	
LHB60CSG60	60	4000	7800	60	1
LHB60CSG90	60	4000	7800	90	1
LHB60DSG60	60	6500	7800	60	1
LHB60DSG90	60	6500	7800	90	1

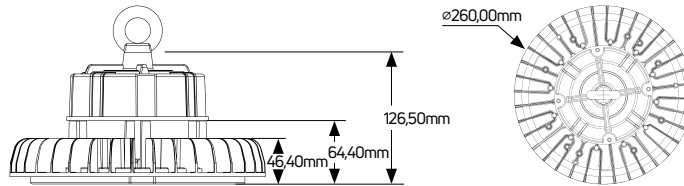

Highbay Premium 100W

YEARS
5
WARRANTY



CODE	WATT	CCT	LUMEN	BEAM ANGLE	
LHB100CSG60	100	4000	13000	60	1
LHB100CSG90	100	4000	13000	90	1
LHB100DSG60	100	6500	13000	60	1
LHB100DSG90	100	6500	13000	90	1

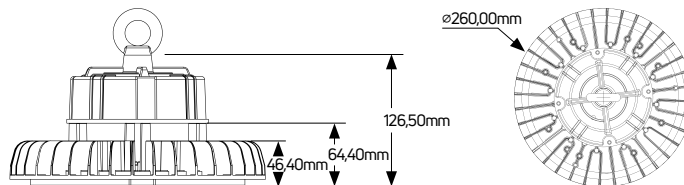

Highbay Premium 150W

YEARS
5
WARRANTY



CODE	WATT	CCT	LUMEN	BEAM ANGLE	
LHB150CSG60	150	4000	19500	60	1
LHB150CSG90	150	4000	19500	90	1
LHB150DSG60	150	6500	19500	60	1
LHB150DSG90	150	6500	19500	90	1

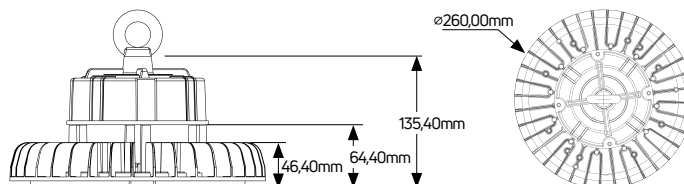

Highbay Premium 200W

YEARS
5
WARRANTY



CODE	WATT	CCT	LUMEN	BEAM ANGLE	
LHB200CSG60	200	4000	26000	60	1
LHB200CSG90	200	4000	26000	90	1
LHB200DSG60	200	6500	26000	60	1
LHB200DSG90	200	6500	26000	90	1

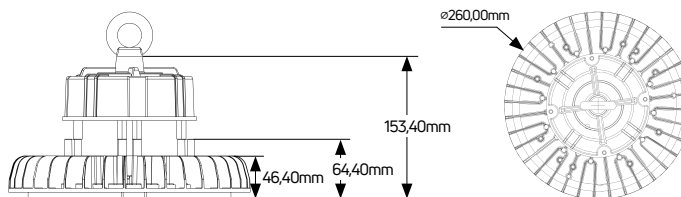

Highbay Premium 240W

YEARS
5
WARRANTY



CODE	WATT	CCT	LUMEN	BEAM ANGLE	
LHB240CSG60	240	4000	31200	60	1
LHB240CSG90	240	4000	31200	90	1
LHB240DSG60	240	6500	31200	60	1
LHB240DSG90	240	6500	31200	90	1

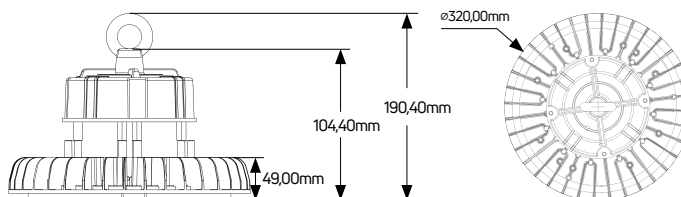

Reflector



CODE	DESCRIPTION	
LHCAP60AL	Aluminum reflector for Highbay Premium 60°	1
LHCAP90AL	Aluminum reflector for Highbay Premium 90°	1

Reflector



CODE	DESCRIPTION	
LHCAP70PC	PC reflector for Highbay Premium 60°	1
LHCAP90PC	PC reflector for Highbay Premium 90°	1

YEARS
5
WARRANTY

LED Linear Highbay 100W



CODE	WATT	CCT	LUMEN	BEAM ANGLE	
LINHB100CAS	100	4000	13000	30*80	1/4

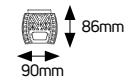
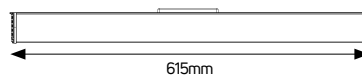

YEARS
5
WARRANTY

LED Linear Highbay 150W



CODE	WATT	CCT	LUMEN	BEAM ANGLE	
LINHB150CAS	150	4000	19500	30*80	1/4

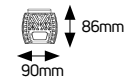
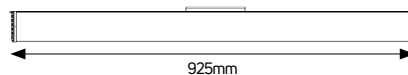

YEARS
5
WARRANTY

LED Linear Highbay 200W



CODE	WATT	CCT	LUMEN	BEAM ANGLE	
LINHB200CAS	200	4000	26000	30*80	1/4

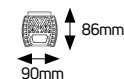
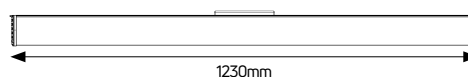

LED Canopy



Canopy 100W Surface/Recessed



CODE	WATT	CCT	LUMEN	
LGSC100SR	100	4000	10000	1/4

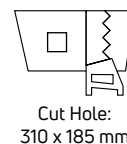
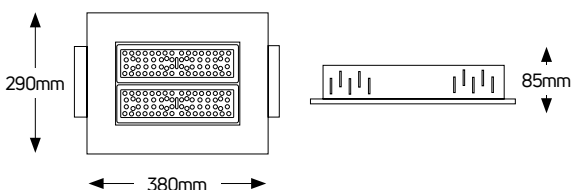

Canopy 150W Surface/Recessed



CODE	WATT	CCT	LUMEN	
LGSC150SR	150	4000	15000	1/4

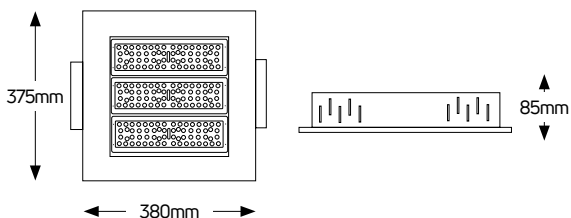

Canopy 200W Surface/Recessed



CODE	WATT	CCT	LUMEN	
LGSC200SR	200	4000	20000	1/4

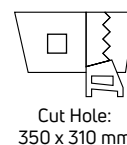
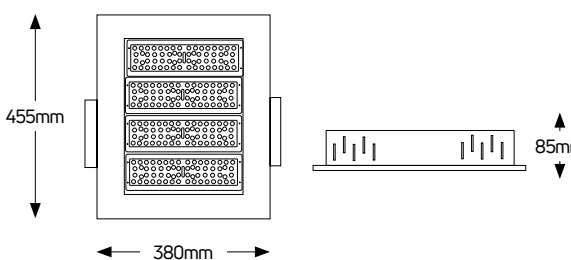

Street Lights



Economy Plus



CODE	WATT	CCT	LUMEN
LSTR.ECP.015.40	15	4000	1500
LSTR.ECP.030.40	30	4000	3000
LSTR.ECP.050.40	50	4000	5000
LSTR.ECP.070.40	70	4000	7000
LSTR.ECP.100.40	100	4000	10000
LSTR.ECP.120.40	120	4000	12000

Economy



CODE	WATT	CCT	LUMEN
LSTR.LRS2.60.40	60	4000	6000
LSTR.LRS2.100.40	100	4000	10000
LSTR.LRS2.150.40	150	4000	15000
LSTR.LRS2.200.40	200	4000	20000

Economy Plus II



CODE	WATT	CCT	LUMEN
LSTR.EC2.025.40	20	4000	2400
LSTR.EC2.035.40	30	4000	3600
LSTR.EC2.060.40	50	4000	6000
LSTR.EC2.085.40	70	4000	8400
LSTR.EC2.120.40	100	4000	12000
LSTR.EC2.145.40	120	4000	14400
LSTR.EC2.180.40	150	4000	18000
LSTR.EC2.210.40	175	4000	21000

Nova



CODE	WATT	CCT	LUMEN
LSTR.NV2.055.40	40	4000	5600
LSTR.NV2.085.40	60	4000	8400
LSTR.NV2.110.40	80	4000	11200
LSTR.NV2.140.40	100	4000	14000
LSTR.NV2.170.40	120	4000	16800
LSTR.NV2.210.40	150	4000	21000
LSTR.NV2.260.40	185	4000	25900

LED Floodlights





Floodlight 10W Black



CODE	WATT	CCT	LUMEN	
LPRM10W3	10	3000	850	1/80
LPRM10C3	10	4000	850	1/80
LPRM10D3	10	6500	850	1/80

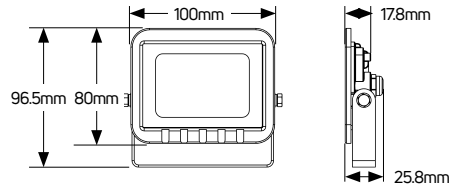

Floodlight 20W Black



CODE	WATT	CCT	LUMEN	
LPRM20W3	20	3000	1700	1/50
LPRM20C3	20	4000	1700	1/50
LPRM20D3	20	6500	1700	1/50

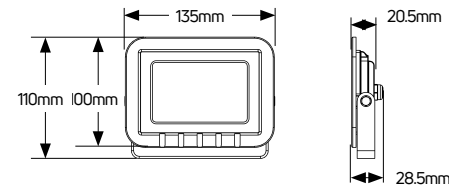

Floodlight 30W Black



CODE	WATT	CCT	LUMEN	
LPRM30W3	30	3000	2550	1/30
LPRM30C3	30	4000	2550	1/30
LPRM30D3	30	6500	2550	1/30

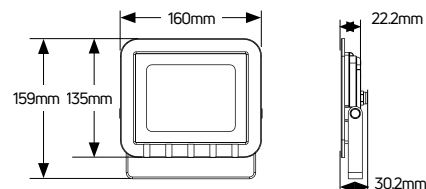

Floodlight 50W Black



CODE	WATT	CCT	LUMEN	
LPRM50W3	50	3000	4250	1/20
LPRM50C3	50	4000	4250	1/20
LPRM50D3	50	6500	4250	1/20

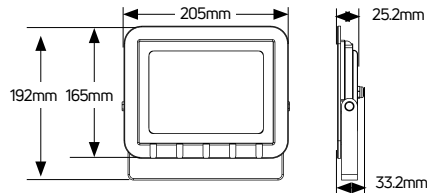

Floodlight 100W Black



CODE	WATT	CCT	LUMEN	
LPRM100W3	100	3000	8500	1/10
LPRM100C3	100	4000	8500	1/10
LPRM100D3	100	6500	8500	1/10

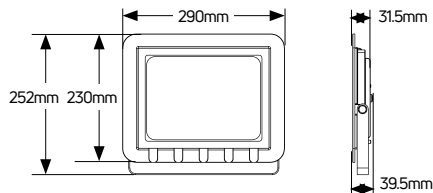

Floodlight 150W Black



CODE	WATT	CCT	LUMEN	
LPRM150W3	150	3000	12750	1/5
LPRM150C3	150	4000	12750	1/5
LPRM150D3	150	6500	12750	1/5

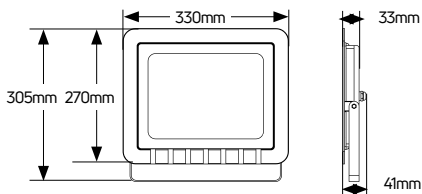

Floodlight 200W Black



CODE	WATT	CCT	LUMEN	
LPRM200W3	200	3000	17000	1/5
LPRM200C3	200	4000	17000	1/5
LPRM200D3	200	6500	17000	1/5

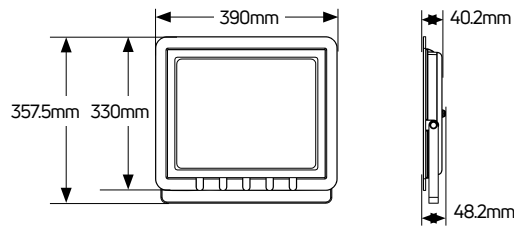

Architectural Illumination



Floodlight 10W White



CODE	WATT	CCT	LUMEN	
LPRW10W3	10	3000	850	1/80
LPRW10C3	10	4000	850	1/80

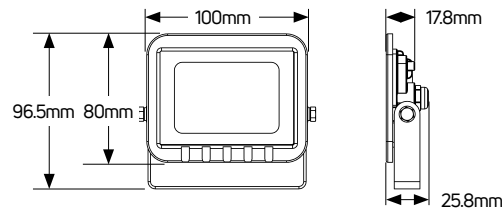

Floodlight 20W White



CODE	WATT	CCT	LUMEN	
LPRW20W3	20	3000	1700	1/50
LPRW20C3	20	4000	1700	1/50

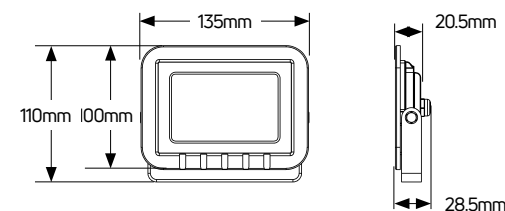

Floodlight 30W White



CODE	WATT	CCT	LUMEN	
LPRW30W3	30	3000	2550	1/30
LPRW30C3	30	4000	2550	1/30

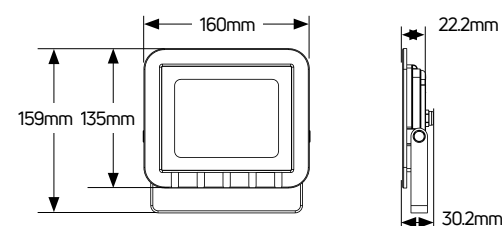

Floodlight 50W White



CODE	WATT	CCT	LUMEN	
LPRW50W3	50	3000	4250	1/20
LPRW50C3	50	4000	4250	1/20

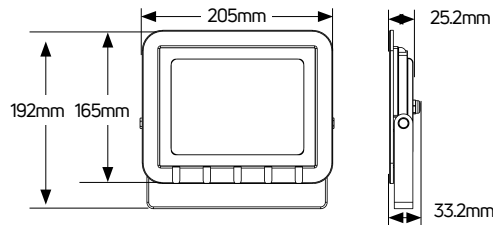

Floodlight 100W White



CODE	WATT	CCT	LUMEN	
LPRW100W3	100	3000	8500	1/10
LPRW100C3	100	4000	8500	1/10

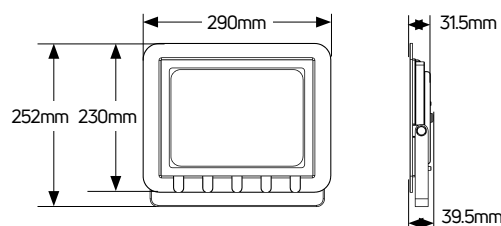



Floodlight 20W Black Sensor



CODE	WATT	CCT	LUMEN	
LPRM20WS3	20	3000	1700	1/30
LPRM20CS3	20	4000	1700	1/30
LPRM20DS3	20	6500	1700	1/30

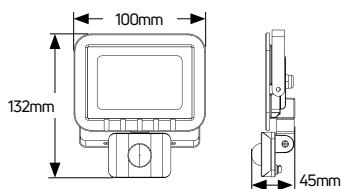

Floodlight 50W Black Sensor



CODE	WATT	CCT	LUMEN	
LPRM50WS3	50	3000	4250	1/20
LPRM50CS3	50	4000	4250	1/20
LPRM50DS3	50	6500	4250	1/20

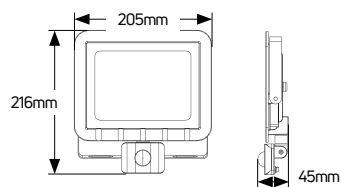



Floodlight 20W White Sensor



CODE	WATT	CCT	LUMEN	
LPRW20WS3	20	3000	1700	1/30
LPRW20CS3	20	4000	1700	1/30

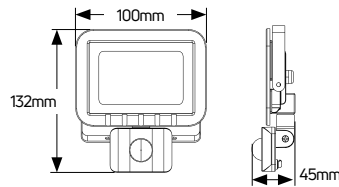

Floodlight 50W White Sensor



CODE	WATT	CCT	LUMEN	
LPRW50WS3	50	3000	4250	1/20
LPRW50CS3	50	4000	4250	1/20

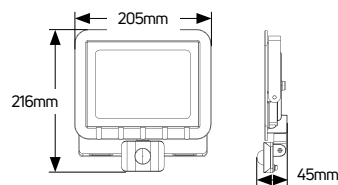

Himor 50W



CODE	WATT	CCT	LUMEN	
LSP.F15.006.30	50	3000	6250	1
LSP.F15.006.40	50	4000	6250	1

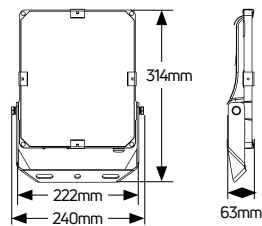

Himor 100W



CODE	WATT	CCT	LUMEN	
LSP.F15.012.30	100	3000	12500	1
LSP.F15.019.40	100	4000	12500	1

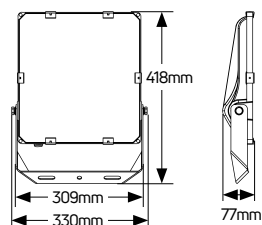

Himor 150W



CODE	WATT	CCT	LUMEN	
LSP.F15.019.30	150	3000	18750	1
LSP.F15.019.40	150	4000	18750	1

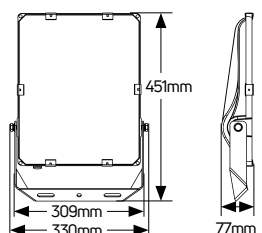



Himor 200W



CODE	WATT	CCT	LUMEN	
LSP.F15.025.30	200	3000	25000	1
LSP.F15.025.40	200	4000	25000	1

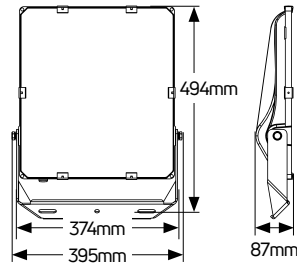

Himor 300W



CODE	WATT	CCT	LUMEN	
LSP.F15.038.30	300	3000	37500	1
LSP.F15.038.40	300	4000	37500	1

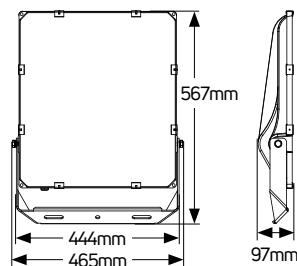

Vario II 150W



CODE	WATT	CCT	LUMEN	
LSP.VL2.025.50	150	5000	21750	1

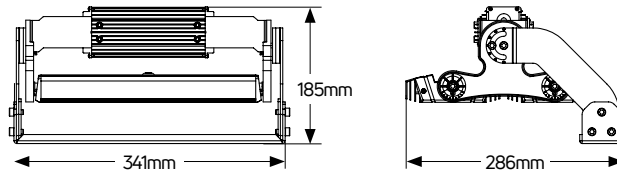

Vario II 220W



CODE	WATT	CCT	LUMEN	
LSP.VL2.035.50	220	5000	31900	1

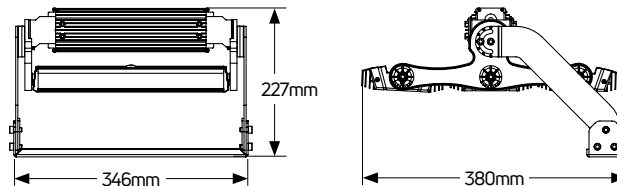

Vario II 300W



CODE	WATT	CCT	LUMEN	
LSP.VL2.045.50	300	5000	43500	1

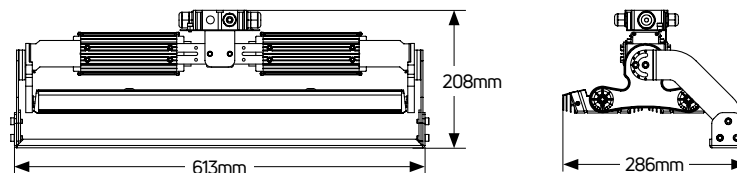



Vario II 450W



CODE	WATT	CCT	LUMEN	
LSPVL2.065.50	450	5000	65250	1

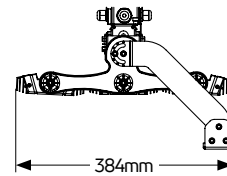
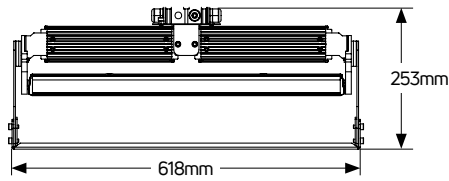

Vario II 600W



CODE	WATT	CCT	LUMEN	
LSPVL2.085.50	600	5000	87000	1

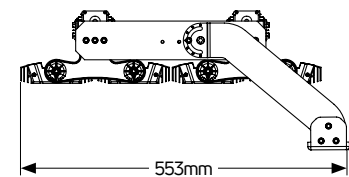
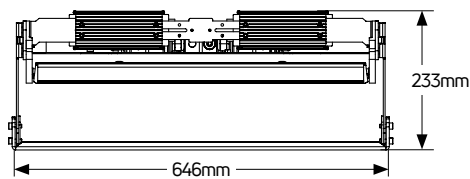

LED Strips



LED Strip 4.8W 12V IP20 Eco



CODE	WATT	VOLT	CCT	LUMEN	
LE48122720	4.8	12V	2700	480	5/150
LE48123020	4.8	12V	3000	480	5/500
LE48124020	4.8	12V	4000	480	5/150
LE48126520	4.8	12V	6500	480	5/150
LE4812RGB20	4.8	12V	RGB		5/150

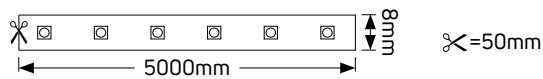

LED Strip 7.2W 12V IP20 Eco



CODE	WATT	VOLT	CCT	LUMEN	
LE72122720	7.2	12V	2700	800	5/150
LE72123020	7.2	12V	3000	800	5/150
LE72124020	7.2	12V	4000	800	5/125
LE72126520	7.2	12V	6500	800	5/125
LE7212RGB20	7.2	12V	RGB		5/125

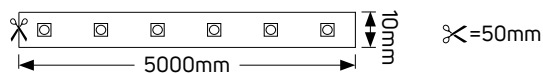

LED Strip 14.4W 12V IP20 Eco



YEARS
2
WARRANTY



CODE	WATT	VOLT	CCT	LUMEN	
LE144122720	14.4	12V	2700	1400	5/150
LE144123020	14.4	12V	3000	1400	5/500
LE144124020	14.4	12V	4000	1400	5/125
LE144126520	14.4	12V	6500	1400	5/125
LE14412RGB20	14.4	12V	RGB		5/150
LE14412RE20	14.4	12V		-	5/125
LE14412GR20	14.4	12V		-	5/125
LE14412YE20	14.4	12V		-	5/125
LE14412BL20	14.4	12V		-	5/125

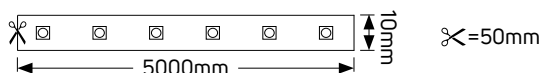

LED Strip 14.4W 24V IP20 Eco



YEARS
2
WARRANTY

24V



CODE	WATT	VOLT	CCT	LUMEN	
LE144242720	14.4	24V	2700	1400	5/150
LE144243020	14.4	24V	3000	1400	5/150
LE144244020	14.4	24V	4000	1400	5/125
LE144246520	14.4	24V	6500	1400	5/125
LE14424RGB20	14.4	24V	RGB		5/125

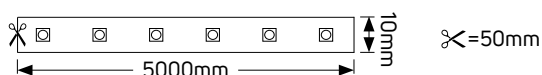

LED Strip 4.8W 12V IP65 Eco



CODE	WATT	VOLT	CCT	LUMEN	
LE48122765	4.8	12V	2700	480	5/150
LE48123065	4.8	12V	3000	480	5/150
LE48124065	4.8	12V	4000	480	5/400
LE48126565	4.8	12V	6500	480	5/150

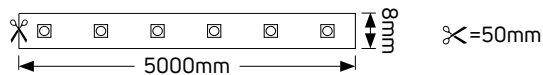

LED Strip 7.2W 12V IP65 Eco



CODE	WATT	VOLT	CCT	LUMEN	
LE72122765	7.2	12V	2700	800	5/150
LE72123065	7.2	12V	3000	800	5/150
LE72124065	7.2	12V	4000	800	5/125
LE72126565	7.2	12V	6500	800	5/125
LE7212RGB65	7.2	12V	RGB		5/150



LED Strip 14.4W 12V IP65 Eco



CODE	WATT	VOLT	CCT	LUMEN	
LE144122765	14.4	12V	2700	1400	5/150
LE144123065	14.4	12V	3000	1400	5/300
LE144124065	14.4	12V	4000	1400	5/125
LE144126565	14.4	12V	6500	1400	5/125
LE14412RGB65	14.4	12V	RGB		5/125

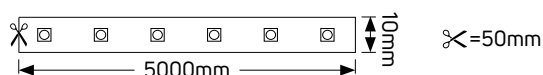



LED Strip Kit



IP65

CODE	DESCRIPTION	
LSKIT144RGB65	LED Strip KIT 14.4W 12V RGB IP65 5m + RGB Controller + Driver	1

LED Strip 4.8W 12V IP33 Premium

YEARS
5
WARRANTY



CODE	WATT	VOLT	CCT	LUMEN	
LP48122733	4.8	12V	2700	420	5/300
LP48123033	4.8	12V	3000	420	5/300
LP48124033	4.8	12V	4000	420	5/300
LP48126533	4.8	12V	6500	420	5/300

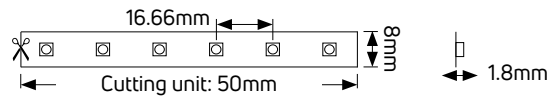

LED Strip 7.2W 12V IP33 Premium

YEARS
5
WARRANTY



CODE	WATT	VOLT	CCT	LUMEN	
LP72122733	7.2	12V	2700	800	5/300
LP72123033	7.2	12V	3000	800	5/300
LP72124033	7.2	12V	4000	800	5/300
LP72126533	7.2	12V	6500	800	5/300
LP7212RGB33	7.2	12V	RGB		5/250

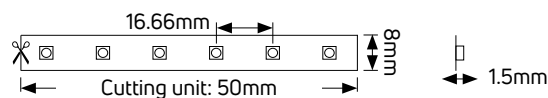



LED Strip 14.4W 12V IP33 Premium



CODE	WATT	VOLT	CCT	LUMEN	
LP144122733	14.4	12V	2700	1400	5/300
LP144123033	14.4	12V	3000	1400	5/300
LP144124033	14.4	12V	4000	1400	5/300
LP144126533	14.4	12V	6500	1400	5/300
LP14412RGB33	14.4	12V	RGB		5/250
LP14412BL33	14.4	12V		1400	5/300
LP14412YE33	14.4	12V		1400	5/300
LP14412RE33	14.4	12V		1400	5/300
LP14412GR33	14.4	12V		1400	5/300

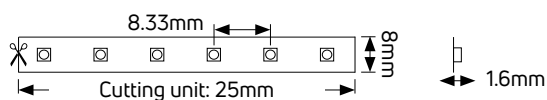

LED Strip 17.3W 24V IP33 Premium



CODE	WATT	VOLT	CCT	LUMEN	
LP173242733	17.3	24V	2700	2000	5/300
LP173243033	17.3	24V	3000	2000	5/300
LP173244033	17.3	24V	4000	2000	5/300
LP173246533	17.3	24V	6500	2000	5/300

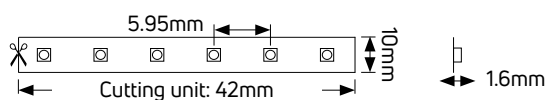

LED Strip 4.8W 12V IP65 Premium



CODE	WATT	VOLT	CCT	LUMEN	
LP48122765	4.8	12V	2700	420	5/300
LP48123065	4.8	12V	3000	420	5/300
LP48124065	4.8	12V	4000	420	5/300
LP48126565	4.8	12V	6500	420	5/300

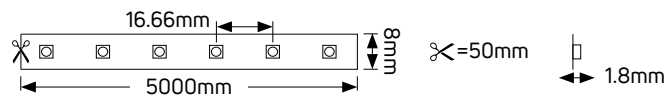

LED Strip 7.2W 12V IP65 Premium



CODE	WATT	VOLT	CCT	LUMEN	
LP72122765	7.2	12V	2700	800	5/300
LP72123065	7.2	12V	3000	800	5/300
LP72124065	7.2	12V	4000	800	5/300
LP72126565	7.2	12V	6500	800	5/300

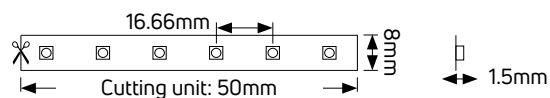



LED Strip 14.4W 12V IP65 Premium



CODE	WATT	VOLT	CCT	LUMEN	
LP144122765	14.4	12V	2700	1400	5/300
LP144123065	14.4	12V	3000	1400	5/300
LP144124065	14.4	12V	4000	1400	5/300
LP144126565	14.4	12V	6500	1400	5/300
LP14412RGB65	14.4	12V	RGB		5/250

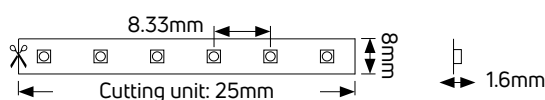

LED Strip 17.3W 24V IP65 Premium



CODE	WATT	VOLT	CCT	LUMEN	
LP173242765	17.3	24V	2700	2000	5/300
LP173243065	17.3	24V	3000	2000	5/300
LP173244065	17.3	24V	4000	2000	5/300
LP173246565	17.3	24V	6500	2000	5/300

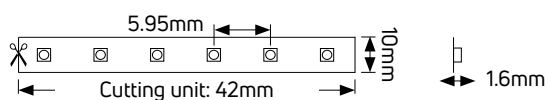

LED Strips Premium

GEYER

LED Strip 14.4W 12V IP68 Premium



CODE	WATT	VOLT	CCT	LUMEN	📦
LP144123068	14.4	12V	3000	1400	5/300
LP144126568	14.4	12V	6500	1400	5/300
LP14412BL68	14.4	12V	●	-	5/300

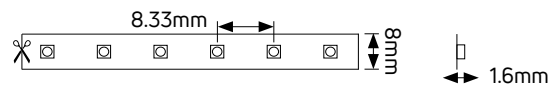

Architectural Illumination



LED Strip 4.8W 24V IP33 Diamond



CODE	WATT	VOLT	CCT	LUMEN	
LD48242733	4.8	24V	2700	480	5/300
LD48243033	4.8	24V	3000	480	5/300
LD48244033	4.8	24V	4000	480	5/300
LD48246533	4.8	24V	6500	480	5/300

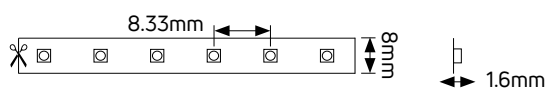

LED Strip 7.2W 24V IP33 Diamond



CODE	WATT	VOLT	CCT	LUMEN	
LD72242733	7.2	24V	2700	1080	5/300
LD72243033	7.2	24V	3000	1080	5/300
LD72244033	7.2	24V	4000	1080	5/300
LD72246533	7.2	24V	6500	1080	5/300

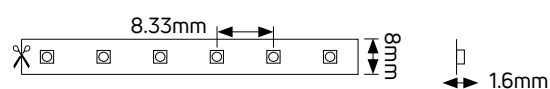

LED Strip 14.4W 24V IP33 Diamond



CODE	WATT	VOLT	CCT	LUMEN	
LD144242733	14.4	24V	2700	2100	5/300
LD144243033	14.4	24V	3000	2100	5/300
LD144244033	14.4	24V	4000	2100	5/300
LD144246533	14.4	24V	6500	2100	5/300

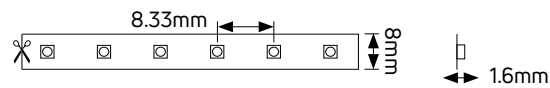

LED Strip 17.3W 24V IP33 Diamond



CODE	WATT	VOLT	CCT	LUMEN	
LD173242733	17.3	24V	2700	2400	5/300
LD173243033	17.3	24V	3000	2400	5/300
LD173244033	17.3	24V	4000	2400	5/300
LD173246533	17.3	24V	6500	2400	5/300

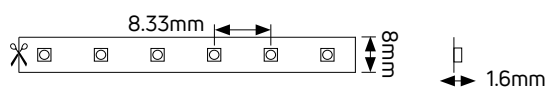

LED Strip 14.4W 24V IP33 COB

YEARS
5
WARRANTY

RA90



CODE	WATT	VOLT	CCT	LUMEN	
LC173242733	14.4	24V	2700	1500	5/300
LC173243033	14.4	24V	3000	1500	5/300
LC173244033	14.4	24V	4000	1500	5/300
LC173246533	14.4	24V	6500	1500	5/300

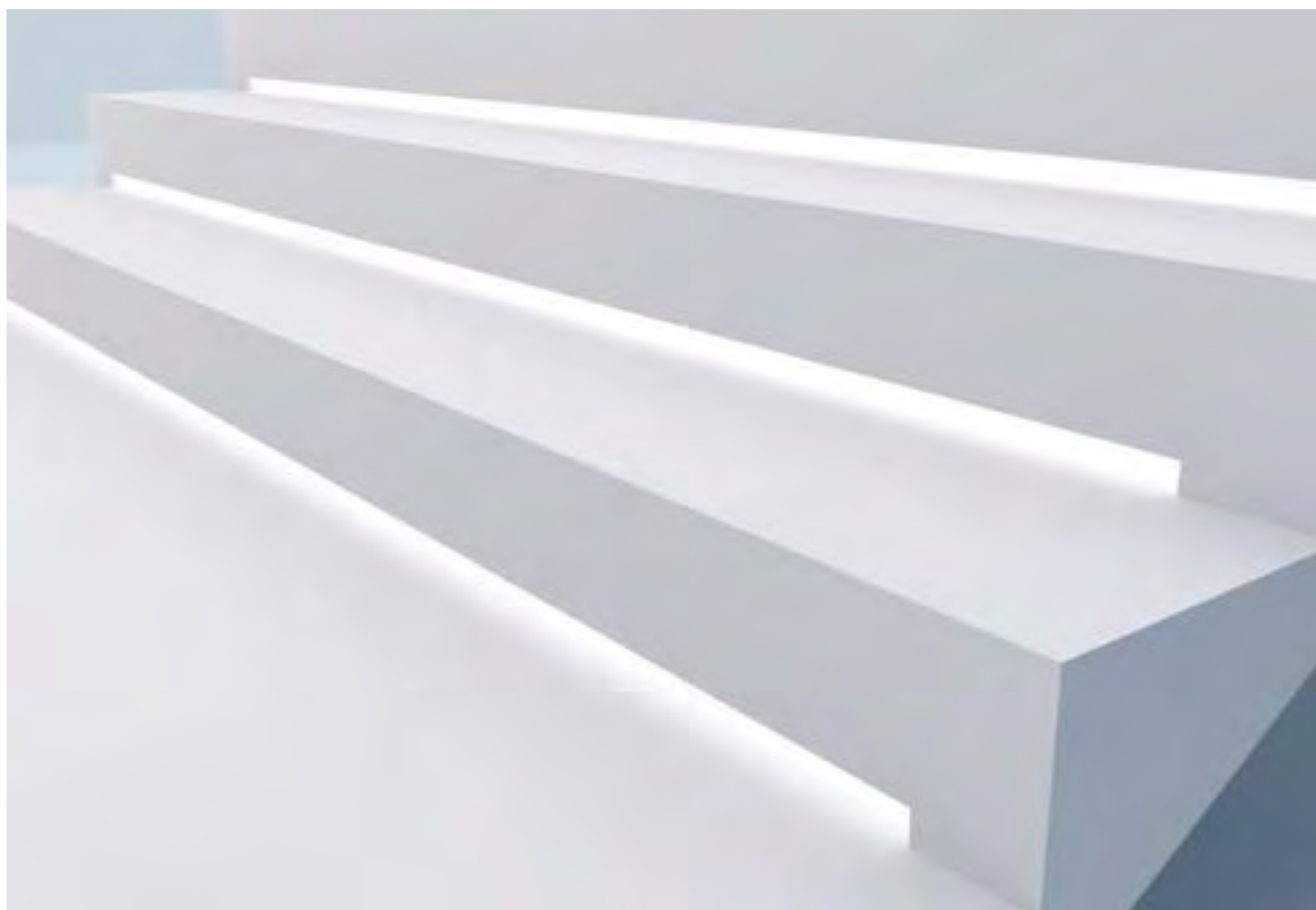
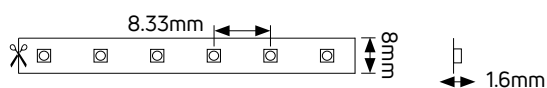

Architectural Illumination



Neon LED strip 24V



CODE	WATT	VOLT	CCT	LUMEN	
LN14461230	144	24V	3000K	1400	5
LN144612R	144	24V		1400	5
LN144612G	144	24V		1400	5
LN144612B	144	24V		1400	5
LNA011	2x Clips for 6x12mm + End caps				

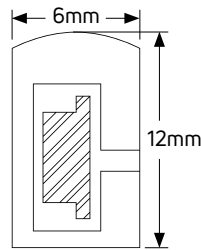

Architectural Illumination



Neon LED strip 24V



CODE	WATT	VOLT	CCT	LUMEN	
LN144951830	14.4	24V	3000K	1400	5
LN1449518R	14.4	24V		1400	5
LN1449518G	14.4	24V		1400	5
LN1449518B	14.4	24V		1400	5
LNA011	2x Clips for 9.5x18mm + End caps				

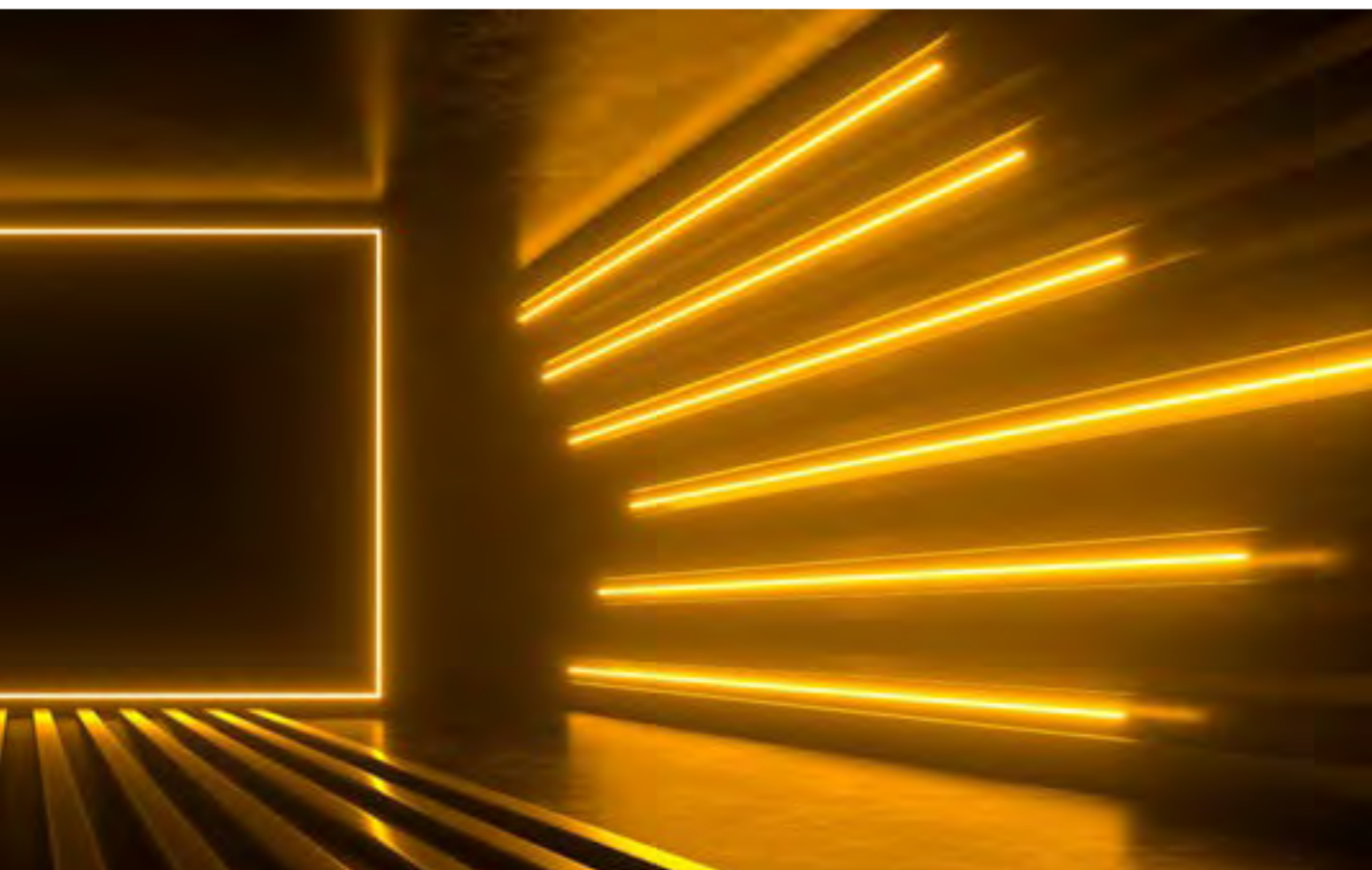
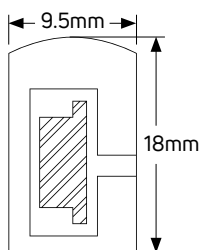



CODE	WATT	OUTPUT VOLTAGE	OUTPUT CURRENT	
LD12P	12	12V DC	1A	1/200
LD24P	24	12V DC	2A	1/150
LD36P	36	12V DC	3A	1/120
LD72P	72	12V DC	6A	1/40



CODE	WATT	OUTPUT VOLTAGE	OUTPUT CURRENT	
LD24P-24	24	24V DC	1A	1/150
LD72P-24	72	24V DC	3A	1/40



CODE	WATT	OUTPUT VOLTAGE	OUTPUT CURRENT	
LD122520	25	12V DC	2A	1
LD242520	25	24V DC	1A	1



CODE	WATT	OUTPUT VOLTAGE	OUTPUT CURRENT	
LD126020	60	12V DC	5A	1
LD244820	48	24V DC	2A	1



CODE	WATT	OUTPUT VOLTAGE	OUTPUT CURRENT	
LD1210020	100	12V DC	8A	1
LD247520	75	24V DC	3A	1



CODE	WATT	OUTPUT VOLTAGE	OUTPUT CURRENT	
LD1215020	150	12V DC	13A	1
LD2412020	120	24V DC	5A	1



CODE	WATT	OUTPUT VOLTAGE	OUTPUT CURRENT	
LD1220020	200	12V DC	17A	1



CODE	WATT	OUTPUT VOLTAGE	OUTPUT CURRENT	
LD1225020F	250	12V DC	21A	1
LD2424020F	240	24V DC	10A	1



CODE	WATT	OUTPUT VOLTAGE	OUTPUT CURRENT	
LD1236020F	360	12V DC	30A	1
LD2436020F	360	24V DC	15A	1

YEARS
3
WARRANTY



IP67
180-265 VAC
-20 +60 °C

CODE	WATT	OUTPUT VOLTAGE	OUTPUT CURRENT	
LD123667	36	12V DC	3A	1
LD243667	36	24V DC	1.5A	1

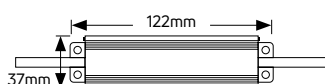

YEARS
3
WARRANTY



IP67
180-265 VAC
-20 +60 °C

CODE	WATT	OUTPUT VOLTAGE	OUTPUT CURRENT	
LD126067	60	12V DC	5A	1
LD246067	60	24V DC	2.5A	1

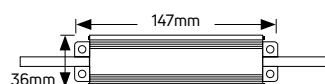

YEARS
3
WARRANTY



IP67
180-265 VAC
-20 +60 °C

CODE	WATT	OUTPUT VOLTAGE	OUTPUT CURRENT	
LD128067	80	12V DC	6.67A	1
LD248067	80	24V DC	3.3A	1

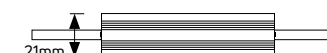
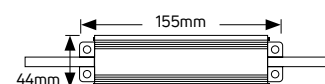



YEARS
3
WARRANTY



CODE	WATT	OUTPUT VOLTAGE	OUTPUT CURRENT	
LD1210067	100	12V DC	8.3A	1
LD2410067	100	24V DC	4.16A	1

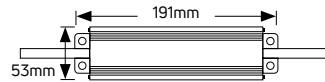

YEARS
3
WARRANTY



CODE	WATT	OUTPUT VOLTAGE	OUTPUT CURRENT	
LD1212067	120	12V DC	10A	1
LD2412067	120	24V DC	5A	1

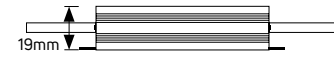
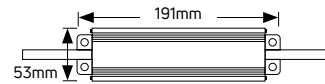

YEARS
3
WARRANTY



CODE	WATT	OUTPUT VOLTAGE	OUTPUT CURRENT	
LD1215067	150	12V DC	12.5A	1
LD2415067	150	24V DC	6.25A	1

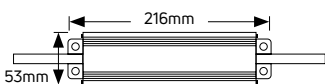

YEARS
3
WARRANTY



CODE	WATT	OUTPUT VOLTAGE	OUTPUT CURRENT	
LD1220067	200	12V DC	16.5A	1
LD2420067	200	24V DC	8.3A	1

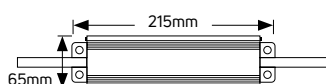

YEARS
3
WARRANTY



CODE	WATT	OUTPUT VOLTAGE	OUTPUT CURRENT	
LD1225067	250	12V DC	20A	1
LD2425067	250	24V DC	10A	1

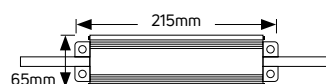

YEARS
3
WARRANTY



CODE	WATT	OUTPUT VOLTAGE	OUTPUT CURRENT	
LD1230067	300	12V DC	25A	1
LD2430067	300	24V DC	12A	1

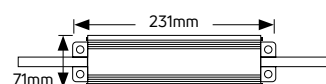



IP20

CODE	DESCRIPTION	
CC1-8	Wire with 1 connector for LED Strip 8mm IP20	1
CC1-10	Wire with 1 connector for LED Strip 10mm IP20	1
CC1-RGB	Wire with 1 connector for LED Strip RGB IP20	1



IP20

CODE	DESCRIPTION	
CC2-8	Wire with 2 connectors for LED Strip 8mm IP20	1
CC2-10	Wire with 2 connectors for LED Strip 10mm IP20	1
CC2-RGB	Wire with 2 connectors for LED Strip RGB IP20	1



IP65

CODE	DESCRIPTION	
CC1-8-65	Wire with 1 connector for LED Strip 8mm IP65	1
CC1-10-65	Wire with 1 connector for LED Strip 10mm IP65	1
CC1-RGB-65	Wire with 1 connector for LED Strip RGB IP65	1



IP65

CODE	DESCRIPTION	
CC2-8-65	Wire with 2 connectors for LED Strip 8mm IP65	1
CC2-10-65	Wire with 2 connectors for LED Strip 10mm IP65	1
CC2-RGB-65	Wire with 2 connectors for LED Strip RGB IP65	1



IP20

CODE	DESCRIPTION	
C-RGB4-M	Wire with 1 male connector for LED Strip RGB IP20	1
C-RGB-F	Wire with 1 female connector for LED Strip RGB IP65	1

IP20



CODE	DESCRIPTION	
CC1-RGB4-M	Wire with 2 male connectors for RGB IP20	1
CC1-RGB-F	Wire with 2 female connectors for RGB IP20	1

IP20



CODE	DESCRIPTION	
CL-8	L shape connector for LED Strip 8mm IP20	1
CL-10	L shape connector for LED Strip 10mm IP20	1
CL-RGB	L shape connector for LED Strip RGB IP20	1

IP20



CODE	DESCRIPTION	
CT-8	T shape connector for LED Strip 8mm IP20	1
CT-10	T shape connector for LED Strip 10mm IP20	1
CT-RGB	T shape connector for LED Strip RGB IP20	1

IP20



CODE	DESCRIPTION	
C4-8	X shape connector for LED Strip 8mm IP20	1
C4-10	X shape connector for LED Strip 10mm IP20	1
C4-RGB	X shape connector for LED Strip RGB IP20	1

IP65

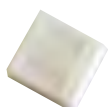

CODE	DESCRIPTION	
C-8-65	Connector for LED Strip 8mm IP65	1
C-10-65	Connector for LED Strip 10mm IP65	1
C-RGB-65	Connector for LED Strip RGB IP65	1



CODE	DESCRIPTION	
CC3382	Connector with wire for LED Strip 8mm IP33	1



CODE	DESCRIPTION	
CC33102	Connector with wire for LED Strip 10mm IP33	1



CODE	DESCRIPTION	
CC33104	Connector with wire for LED Strip RGB IP33	1



CODE	DESCRIPTION	
C3382	Straight Connector for LED Strip 8mm IP33	1



CODE	DESCRIPTION	
C33102	Straight Connector for LED Strip 10mm IP33	1



CODE	DESCRIPTION	
C33104	Straight Connector for LED Strip RGB 10mm IP33	1



CODE	DESCRIPTION	
C33120	Wire for LED Strip 4.8W, 7.2W, 9.6W, 17.3W IP33 120mm	1



CODE	DESCRIPTION	
C33144	Wire for LED Strip 14.4W IP33 120mm	1



CODE	DESCRIPTION	
C334	Wire for LED Strip RGB IP33 120mm	1



CODE	DESCRIPTION	
CC5582	Connector with wire for LED Strip 8mm IP65	1



CODE	DESCRIPTION	
CC55102	Connector with wire for LED Strip 10mm IP65	1



CODE	DESCRIPTION	
CC55104	Connector with wire for LED Strip RGB IP65	1



CODE	DESCRIPTION	
C5582	Straight Connector for LED Strip 8mm IP65	1



CODE	DESCRIPTION	
C55102	Straight Connector for LED Strip 10mm IP65	1



CODE	DESCRIPTION	
C55104	Straight Connector for LED Strip RGB 10mm IP65	1



CODE	DESCRIPTION	
C65200	Wire for LED Strip 4.8W, 7.2W, 9.6W, 17.3W IP65 / IP68 200mm	1



CODE	DESCRIPTION	
C65144	Wire for LED Strip 14.4W IP65 / IP68 200mm	1



CODE	DESCRIPTION	
C654	Wire for LED Strip RGB IP65 / IP68 150mm	1



CODE	DESCRIPTION	
T688	Silicone cap set for LED Strip 8mm IP68	1



CODE	DESCRIPTION	
GT68	Silicone gel for waterproof LED Strip	1



CODE	DESCRIPTION	12V	24V	
LDM1296	Monochrome knob dimmer	96W	192W	1



CODE	DESCRIPTION	12V	24V	
LDM12360	360W knob dimmer	360W	720W	1



CODE	DESCRIPTION	12V	24V	
LDRF1296	Wireless 3 button 30A	360W	720W	1



CODE	DESCRIPTION	12V	24V	
LDRF12216	Wireless touch monotone light controller	216W	432W	1



CODE	DESCRIPTION	WATT	
LDMS1272	Human body infrared sensor switch	72	1



CODE	DESCRIPTION	12V	24V	
LDPT12144	Panel touch monotone lighter	144W	288W	1



CODE	DESCRIPTION	12V	24V	
L24KIR1272	Infrared aluminum shell 24-key RGB controller	216W	432W	1



CODE	DESCRIPTION	12V	24V	
L44KIR1272	Infrared aluminum shell 44-key RGB controller	216W	432W	1



CODE	DESCRIPTION	12V	24V	
L28KRF12144	Wireless aluminum shell 28-key RGB controller	144W	288W	1



CODE	DESCRIPTION	12V	24V	
L44KRF12144	Wireless aluminum shell 44-key RGB controller	144W	288W	1



CODE	DESCRIPTION	12V	24V	
LTKRF12288	2.4G network port synchronous RGB controller	288W	576W	1



CODE	DESCRIPTION	12V	24V	
LTKRF12216	Wireless touch RGB controller	216W	432W	1





CODE	DESCRIPTION	12V	24V	
LRGBPT12216	Touch RGB controller	144W	288W	1

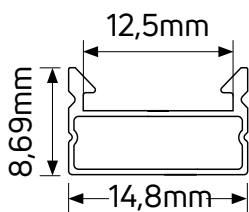

CODE	DESCRIPTION	
AL502*	Alu Profile AL502 up to 10mm LED Strip	2
502-PC*	Cover for AL502	2
502-PL	Inox base for AL502	1
502-SN	Snap for AL502	1

***Available in 2 meters profile.**



CODE	DESCRIPTION	
AL601*	Alu Profile AL601 up to 10mm LED Strip	2
601-PC*	Cover for AL601	2
601-PL	Inox base for AL601	1
601-SN	Snap for AL601	1

***Available in 2 meters profile.**

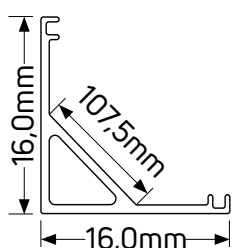



CODE	DESCRIPTION	
AL004A*	Alu Profile AL004A up to 10mm LED Strip	2
004A-PC*	Cover for AL004A	2
004A-PL	Inox base for AL004A	1
004A-SN	Snap for AL004A	1

*Available in 2 meters profile.

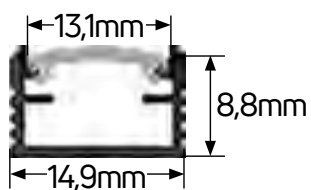

CODE	DESCRIPTION	
AL014*	Alu Profile AL014 up to 10mm LED Strip	2
014-PC*	Cover for AL014	2
014-PL	Inox base for AL014	1
014-SN	Snap for AL014	1

*Available in 2 meters profile.

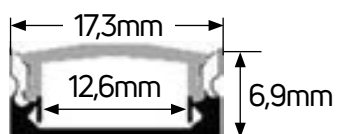



CODE	DESCRIPTION	
AL018*	Alu Profile AL018 up to 10mm LED Strip	2

***Available in 2 meters profile.**

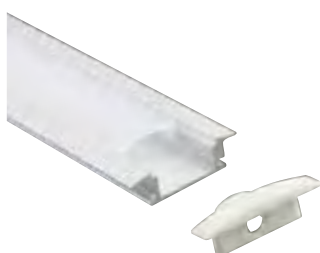
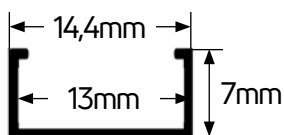

CODE	DESCRIPTION	
AL019*	Alu Profile AL019 up to 10mm LED Strip	2
019-PC*	Cover for AL019	2
019-PL	Inox base for AL019	1
019-SN	Snap for AL019	1

***Available in 2 meters profile.**

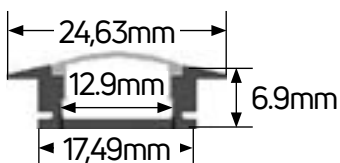

CODE	DESCRIPTION	
AL024*	Alu Profile AL024 up to 10mm LED Strip	2
024-PC*	Cover for AL024	2
024-PL	Inox base for AL024	1
024-SN	Snap for AL024	1

***Available in 2 meters profile.**

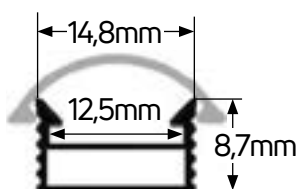



CODE	DESCRIPTION	
AL026*	Alu Profile AL026 up to 10mm LED Strip	2

*Available in 2 meters profile.

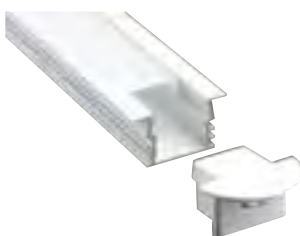
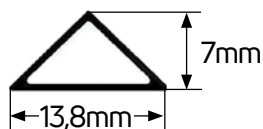

CODE	DESCRIPTION	
AL043*	Alu Profile AL043 up to 10mm LED Strip	2
043-PC*	Cover for AL043	2
043-PL	Inox base for AL043	1
043-SN	Snap for AL043	1

*Available in 2 meters profile.

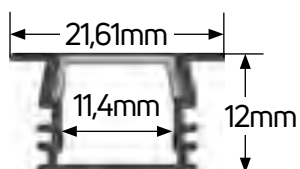

CODE	DESCRIPTION	
AL069*	Alu Profile AL069 up to 10mm LED Strip	2
069-PC*	Cover for AL069	2
069-PL	Inox base for AL069	1
069-SN	Snap for AL069	1

*Available in 2 meters profile.

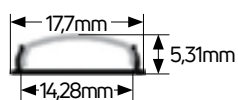

Track Lights

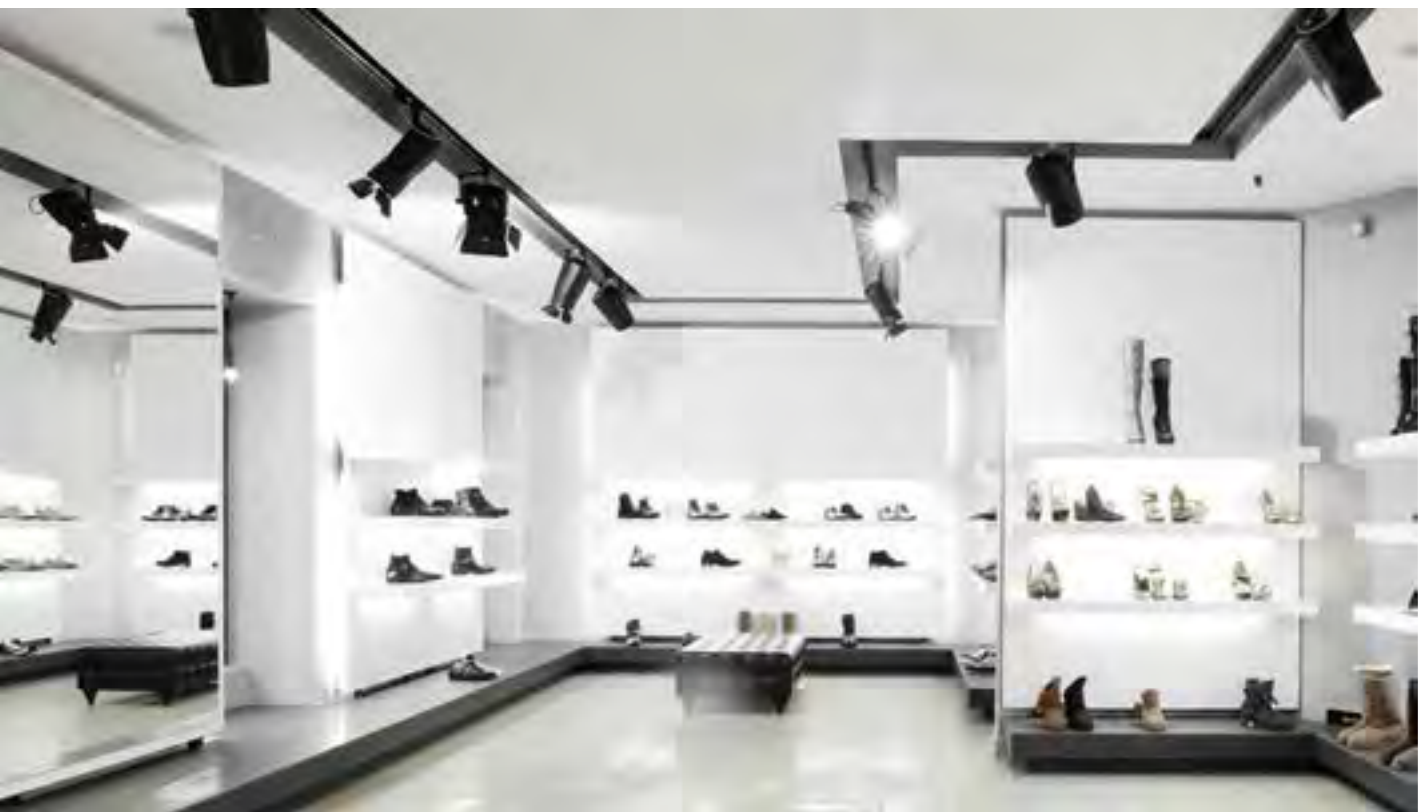

Track light 15W



CODE		WATT	BEAM ANGLE	CCT	LUMEN	
LTRW251525B	●	15	25	3000	1370	1/18
LTRW251545B	●	15	45	3000	1370	1/18
LTRC251525B	●	15	25	4000	1420	1/18
LTRC251545B	●	15	45	4000	1420	1/18
LTRW251525W	○	15	25	3000	1370	1/18
LTRW251545W	○	15	45	3000	1370	1/18
LTRC251525W	○	15	25	4000	1420	1/18
LTRC251545W	○	15	45	4000	1420	1/18

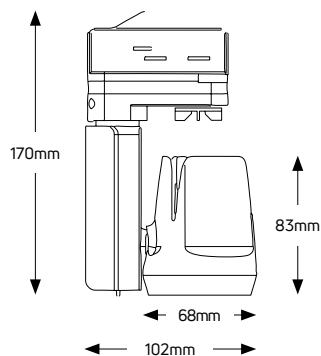

YEARS
5
WARRANTY



Track light 25W



CODE		WATT	BEAM ANGLE	CCT	LUMEN	
LTRW252515B	●	25	15	3000	2430	1/12
LTRW252524B	●	25	24	3000	2430	1/12
LTRW252536B	●	25	36	3000	2430	1/12
LTRC252515B	●	25	15	4000	2520	1/12
LTRC252524B	●	25	24	4000	2520	1/12
LTRC252536B	●	25	36	4000	2520	1/12
LTRW252515W	○	25	15	3000	2430	1/12
LTRW252524W	○	25	24	3000	2430	1/12
LTRW252536W	○	25	36	3000	2430	1/12
LTRC252515W	○	25	15	4000	2520	1/12
LTRC252524W	○	25	24	4000	2520	1/12
LTRC252536W	○	25	36	4000	2520	1/12

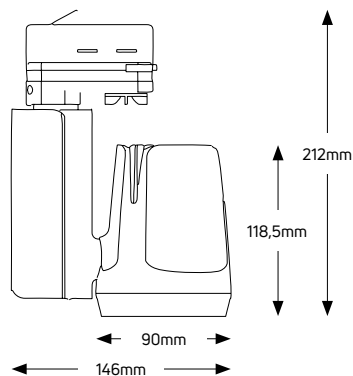

LED Track light 35W

YEARS
5
WARRANTY



CODE		WATT	BEAM ANGLE	CCT	LUMEN	
LTRW253515B	●	35	15	3000	3570	1/12
LTRW253524B	●	35	24	3000	3570	1/12
LTRW253536B	●	35	36	3000	3570	1/12
LTRC253515B	●	35	15	4000	3800	1/12
LTRC253524B	●	35	24	4000	3800	1/12
LTRC253536B	●	35	36	4000	3800	1/12
LTRW253515W	○	35	15	3000	3570	1/12
LTRW253524W	○	35	24	3000	3570	1/12
LTRW253536W	○	35	36	3000	3570	1/12
LTRC253515W	○	35	15	4000	3800	1/12
LTRC253524W	○	35	24	4000	3800	1/12
LTRC253536W	○	35	36	4000	3800	1/12

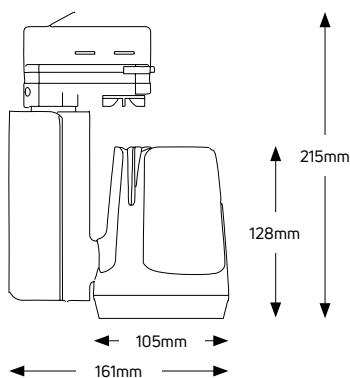

YEARS
5
WARRANTY



LED Track light 45W



CODE		WATT	BEAM ANGLE	CCT	LUMEN	
LTRW254515B	●	45	15	3000	4110	1/12
LTRW254524B	●	45	24	3000	4110	1/12
LTRW254536B	●	45	36	3000	4110	1/12
LTRC254515B	●	45	15	4000	4260	1/12
LTRC254524B	●	45	24	4000	4260	1/12
LTRC254536B	●	45	36	4000	4260	1/12
LTRW254515W	○	45	15	3000	4110	1/12
LTRW254524W	○	45	24	3000	4110	1/12
LTRW254536W	○	45	36	3000	4110	1/12
LTRC254515W	○	45	15	4000	4260	1/12
LTRC254524W	○	45	24	4000	4260	1/12
LTRC254536W	○	45	36	4000	4260	1/12

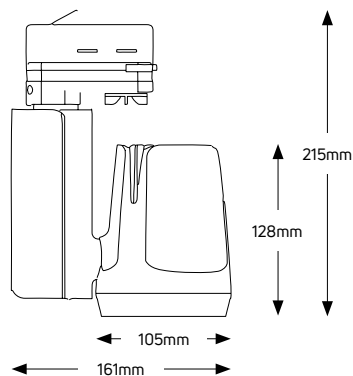



LED Track light adjustable beam angle 30W



CODE	WATT	CCT	LUMEN	
LTRA30WB	30	3000	2800	1/12
LTRA30CB	30	4000	2800	1/12

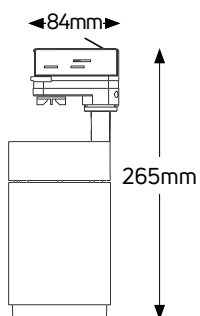





LED Track light 15W



CODE		WATT	BEAM ANGLE	CCT	LUMEN	
LTR602925B	●	15	25	2700	1050	1/20
LTR602940B	●	15	40	2700	1050	1/20
LTR602925W	○	15	25	2700	1050	1/20
LTR602940W	○	15	40	2700	1050	1/20

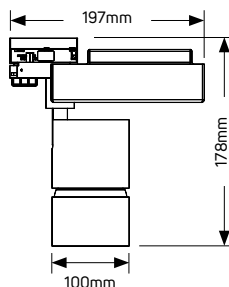

LED Track light 30W



CODE		WATT	BEAM ANGLE	CCT	LUMEN	
LTR605725B	●	30	25	2700	2100	1/16
LTR605740B	●	30	40	2700	2100	1/16
LTR605725W	○	30	25	2700	2100	1/16
LTR605740W	○	30	40	2700	2100	1/16

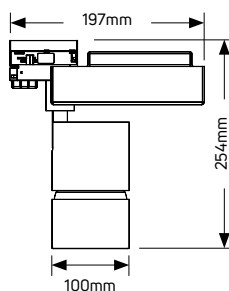

YEARS
5
WARRANTY



LED Track light 45W



CODE		WATT	BEAM ANGLE	CCT	LUMEN	
LTR6027PLS25B	●	45	25	2700	3150	1/10
LTR6027PLS40B	●	45	40	2700	3150	1/10
LTR6027PLS25W	○	45	25	2700	3150	1/10
LTR6027PLS40W	○	45	40	2700	3150	1/10

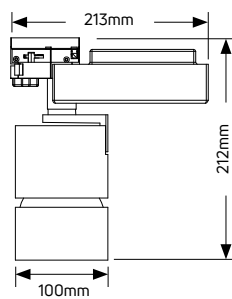

Architectural Illumination





CODE		DESCRIPTION	
LTR0154E27B	●	Track light for PAR30/E27	1/9
LTR0154E27W	○	Track light for PAR30/E27	1/9

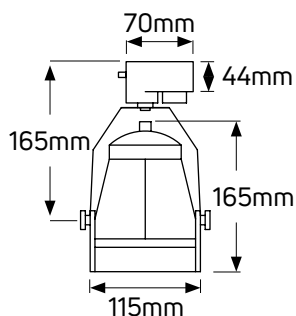

CODE		DESCRIPTION	
LTR0664E27B	●	Track light for PAR30/E27	1/24
LTR0664E27W	○	Track light for PAR30/E27	1/24

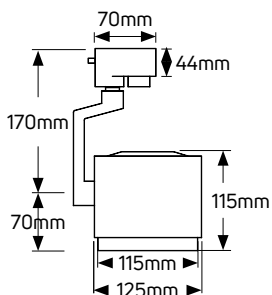

CODE		DESCRIPTION	
LTR1194E27B	●	Track light for PAR30/E27	1/9
LTR1194E27W	○	Track light for PAR30/E27	1/9



CODE		DESCRIPTION	
LTR0014GU10B	●	Track light for PAR16/GU10	1/50
LTR0014GU10W	○	Track light for PAR16/GU10	1/50

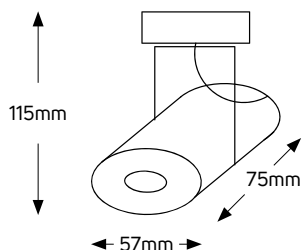

CODE		DESCRIPTION	
LTR2114GU10B	●	Track light for PAR16/GU10	1/28
LTR2114GU10W	○	Track light for PAR16/GU10	1/28

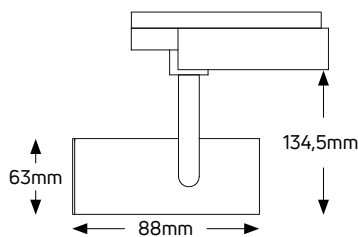

CODE		DESCRIPTION	
LTR6046GU10B	●	Track light for PAR16/GU10	1/20
LTR6046GU10W	○	Track light for PAR16/GU10	1/20

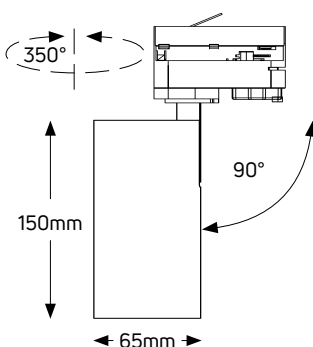



CODE		DESCRIPTION	
LTR1034GU10B	●	Track light for PAR16/GU10	1/25
LTR1034GU10W	○	Track light for PAR16/GU10	1/25

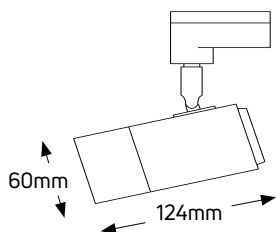

CODE		DESCRIPTION	
LTR0674GU10B	●	Track light for AR111/GU10	1/24
LTR0674GU10W	○	Track light for AR111/GU10	1/24

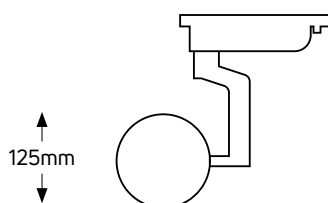

CODE		DESCRIPTION	
LTR0854GU10B	●	Track light for PAR16/GU10	1/48
LTR0854GU10W	○	Track light for PAR16/GU10	1/48

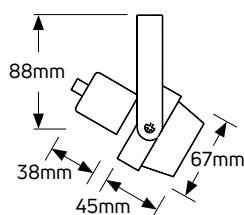





CODE		WATT	CCT	LUMEN	
LTRL16WB	●	16	3000	1800	1/12
LTRL16CB	●	16	4000	1800	1/12
LTRL16WW	○	16	3000	1800	1/12
LTRL16CW	○	16	4000	1800	1/12



CODE	WATT	LENGTH	CCT	LUMEN	
LTRLI40W	40	1100mm	3000	5200	1/10
LTRLI40C	40	1100mm	4000	5200	1/10





CODE	WATT	LENGTH	CCT	LUMEN	
LTRLI50W	50	1350mm	3000	6000	1/10
LTRLI50C	50	1350mm	4000	6000	1/10

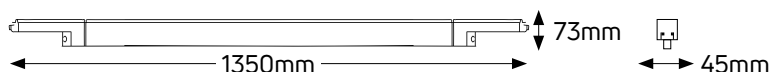

CODE	WATT	LENGTH	CCT	LUMEN	
LTRLI60W	60	1350mm	3000	7200	1/10
LTRLI60C	60	1350mm	4000	7200	1/10

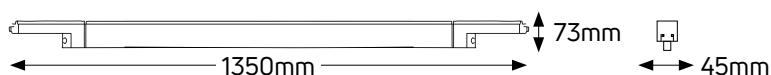



CODE	WATT	LENGTH	CCT	LUMEN	
LTRLAIxx15W	15	370mm	3000	2000	1/10
LTRLAIxx15C	15	370mm	4000	2000	1/10

*xx=30 for beam angle 30°
xx=60 for beam angle 60°
xx=90 for beam angle 90°
xx=120 for beam angle 120°

xx=W60 for beam angle Wide 60°
xx=W90 for beam angle Wide 90°
xx=SYM for beam angle symmetric
xx=ASYM for beam angle asymmetric

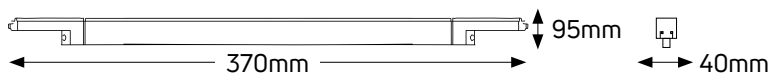

CODE	WATT	LENGTH	CCT	LUMEN	
LTRLAIxx30W	30	650mm	3000	3900	1/10
LTRLAIxx30C	30	650mm	4000	3900	1/10

*xx=30 for beam angle 30°
xx=60 for beam angle 60°
xx=90 for beam angle 90°
xx=120 for beam angle 120°

xx=W60 for beam angle Wide 60°
xx=W90 for beam angle Wide 90°
xx=SYM for beam angle symmetric
xx=ASYM for beam angle asymmetric

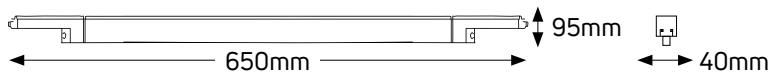

YEARS
5
WARRANTY



CODE	WATT	LENGTH	CCT	LUMEN	
LTRLAIxx50W	50	930mm	3000	6500	1/10
LTRLAIxx50C	50	930mm	4000	6500	1/10

*xx=30 for beam angle 30°
xx=60 for beam angle 60°
xx=90 for beam angle 90°
xx=120 for beam angle 120°

xx=W60 for beam angle Wide 60°
xx=W90 for beam angle Wide 90°
xx=SYM for beam angle symmetric
xx=ASYM for beam angle asymmetric

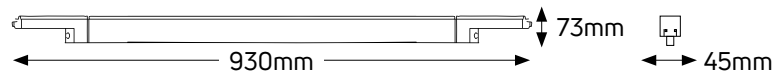

YEARS
5
WARRANTY



CODE	WATT	LENGTH	CCT	LUMEN	
LTRLAIxx70W	70	1210mm	3000	9100	1/10
LTRLAIxx70C	70	1210mm	4000	9100	1/10

*xx=30 for beam angle 30°
xx=60 for beam angle 60°
xx=90 for beam angle 90°
xx=120 for beam angle 120°

xx=W60 for beam angle Wide 60°
xx=W90 for beam angle Wide 90°
xx=SYM for beam angle symmetric
xx=ASYM for beam angle asymmetric

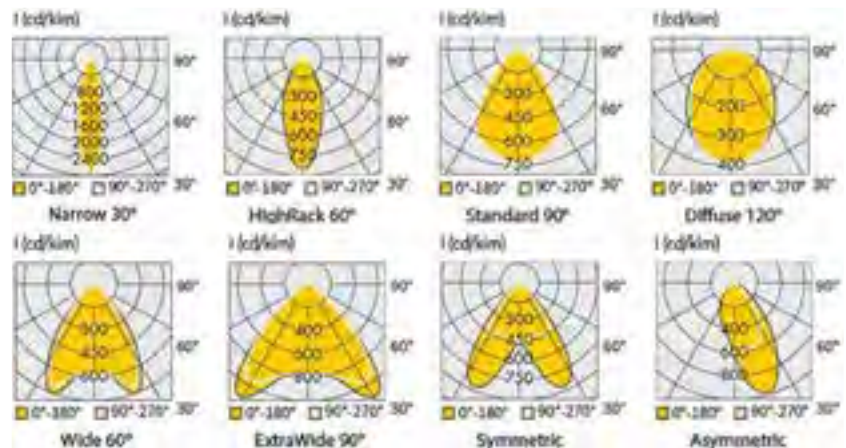
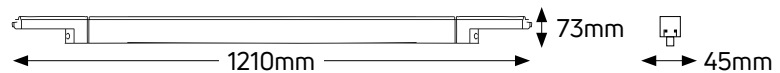

Track Lights

Accessories for surface/hanging installation

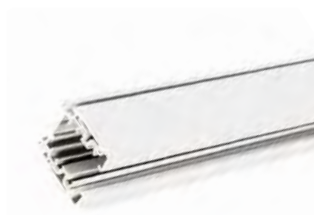

4WIRE 3PHASE 2 YEARS WARRANTY

CODE		DESCRIPTION	
LTR-B	●	3-phase track rail aluminium	1/8
LTR-W	○	3-phase track rail aluminium	1/8

*Available in 3 meters Track Rail, can be cut per meter.

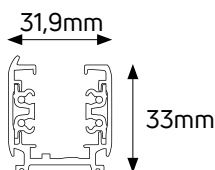

4WIRE 3PHASE 2 YEARS WARRANTY

CODE		DESCRIPTION	
LTC-B	●	Straight connector 3-phase	1/50
LTC-W	○	Straight connector 3-phase	1/50

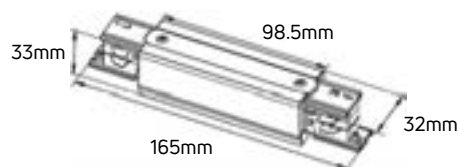

4WIRE 3PHASE 2 YEARS WARRANTY

CODE		DESCRIPTION	
LTCM-B	●	Straight connector 3-phase	1/50
LTCM-W	○	Straight connector 3-phase	1/50

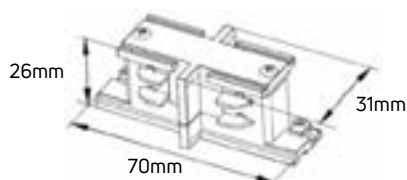

Track Lights

Accessories for surface/hanging installation

GEYER

4WIRE 3PHASE 2 YEARS WARRANTY



CODE		DESCRIPTION	
LTC-L-B	●	L connector 3-phase	1/50
LTC-L-W	○	L connector 3-phase	1/50

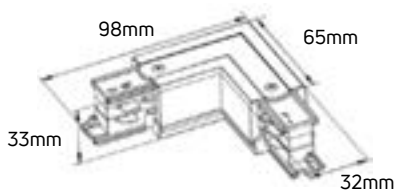

4WIRE 3PHASE 2 YEARS WARRANTY



CODE		DESCRIPTION	
LTC-T-B	●	T connector 3-phase	1/50
LTC-T-W	○	T connector 3-phase	1/50

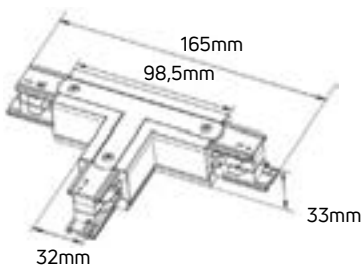

4WIRE 3PHASE 2 YEARS WARRANTY



CODE		DESCRIPTION	
LTC-X-B	●	X connector 3-phase	1/40
LTC-X-W	○	X connector 3-phase	1/40

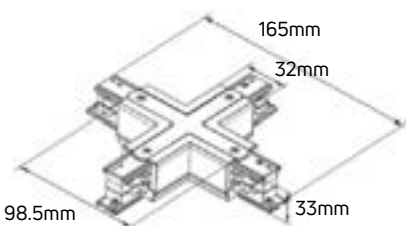

Architectural Illumination

Track Lights

Accessories for surface/hanging installation

4WIRE 3PHASE 2 YEARS WARRANTY



CODE		DESCRIPTION	
LTPS-B	●	AC Power supply 3-phase	1/50
LTPS-W	○	AC Power supply 3-phase	1/50

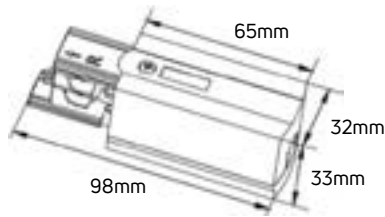

4WIRE 3PHASE 2 YEARS WARRANTY



CODE		DESCRIPTION	
LTHC-B	●	Hanging kit 2.5m	1/100
LTHC-W	○	Hanging kit 2.5m	1/100

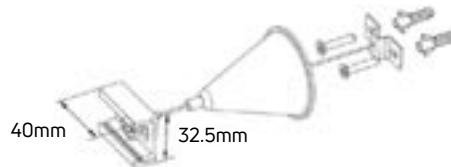

4WIRE 3PHASE 2 YEARS WARRANTY



CODE		DESCRIPTION	
LTEC-B	●	End cap for track rail	1/150
LTEC-W	○	End cap for track rail	1/150

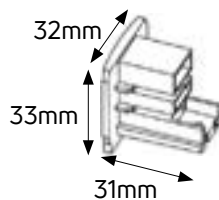

Track Lights

Accessories for recessed installation

4WIRE 3PHASE 2 YEARS WARRANTY



CODE	DESCRIPTION	
RLTR-B ●	Recessed 3-phase track rail aluminum	1/8
RLTR-W ○	Recessed 3-phase track rail aluminum	1/8

*Available in 3 meters Track Rail, can be cut per meter.

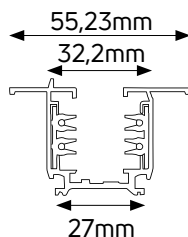

4WIRE 3PHASE 2 YEARS WARRANTY



CODE	DESCRIPTION	
RLTC-B ●	Straight recessed connector 3-phase	1/50
RLTC-W ○	Straight recessed connector 3-phase	1/50

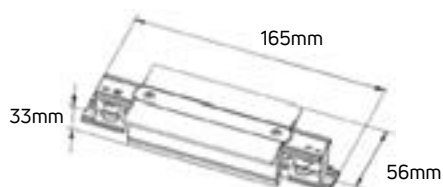

4WIRE 3PHASE 2 YEARS WARRANTY



CODE	DESCRIPTION	
LTCM-B ●	Straight recessed connector mini 3-phase	1/50
LTCM-W ○	Straight recessed connector mini 3-phase	1/50

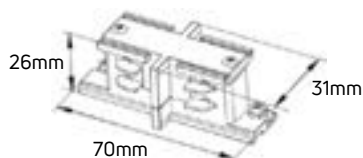

Track Lights

Accessories for recessed installation

4WIRE 3PHASE 2 YEARS WARRANTY



CODE	DESCRIPTION	
RLTC-L-B ●	Recessed L connector 3-phase	1/50
RLTC-L-W ○	Recessed L connector 3-phase	1/50

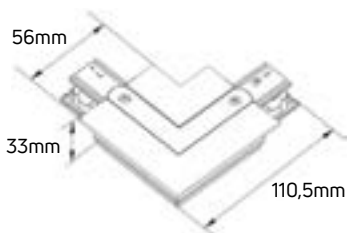

4WIRE 3PHASE 2 YEARS WARRANTY



CODE	DESCRIPTION	
RLTC-T-B ●	Recessed T connector 3-phase	1/25
RLTC-T-W ○	Recessed T connector 3-phase	1/25

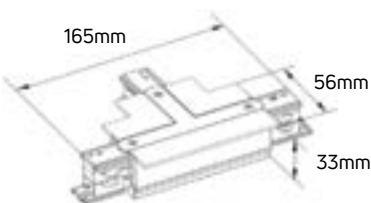

4WIRE 3PHASE 2 YEARS WARRANTY



CODE	DESCRIPTION	
RLTC-X-B ●	Recessed X connector 3-phase	1/25
RLTC-X-W ○	Recessed X connector 3-phase	1/25

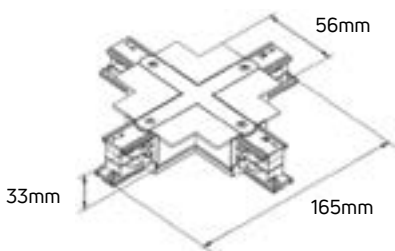

4WIRE 3PHASE 2 YEARS WARRANTY



CODE	DESCRIPTION	
RLTPS-B ●	Recessed AC Power supply 3-phase	1/50
RLTPS-W ○	Recessed AC Power supply 3-phase	1/50

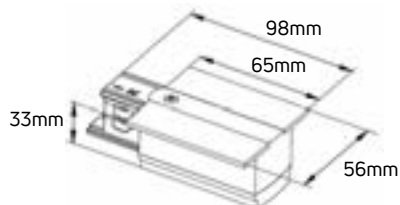

4WIRE 3PHASE 2 YEARS WARRANTY



CODE	DESCRIPTION	
LTEC-B ●	End cap for track rail recessed	1/150
LTEC-W ○	End cap for track rail recessed	1/150

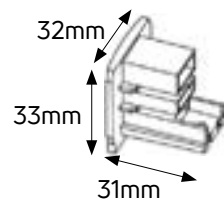





Linear Lights

Linear Lights

LED Line

GEYER



CODE		WATT	CCT	LUMEN	
LLUT-0.6WDB	●	18	3000	2250	1/12
LLUT-0.6CDB	●	18	4000	2340	1/12
LLUT-0.6WDW	○	18	3000	2250	1/12
LLUT-0.6CDW	○	18	4000	2340	1/12
LLUT-0.6WD	●	18	3000	2250	1/12
LLUT-0.6CD	●	18	4000	2340	1/12

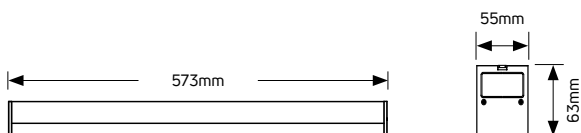

Tools for surface mounting and hanging included

Architectural Illumination

Linear Lights

LED Line

GEYER



CODE		WATT	CCT	LUMEN	
LLUT-1.2WDB	●	30	3000	3750	1/12
LLUT-1.2CDB	●	30	4000	3900	1/12
LLUT-1.2WDW	○	30	3000	3750	1/12
LLUT-1.2CDW	○	30	4000	3900	1/12
LLUT-1.2WD	●	30	3000	3750	1/12
LLUT-1.2CD	●	30	4000	3900	1/12

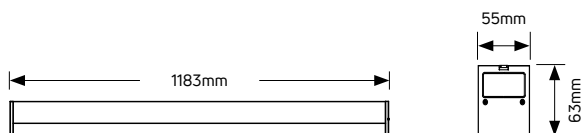

Tools for surface mounting and hanging included

Architectural Illumination

Linear Lights

LED Line

GEYER



CODE		WATT	CCT	LUMEN	
LLUT-1.5WDB	●	50	3000	6250	1/12
LLUT-1.5CDB	●	50	4000	6500	1/12
LLUT-1.5WDW	○	50	3000	6250	1/12
LLUT-1.5CDW	○	50	4000	6500	1/12
LLUT-1.5WD	●	50	3000	6250	1/12
LLUT-1.5CD	●	50	4000	6500	1/12

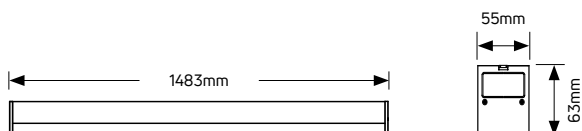

Tools for surface mounting and hanging included

Architectural Illumination

Linear Lights

LED Line Recessed

GEYER



YEARS
5
WARRANTY

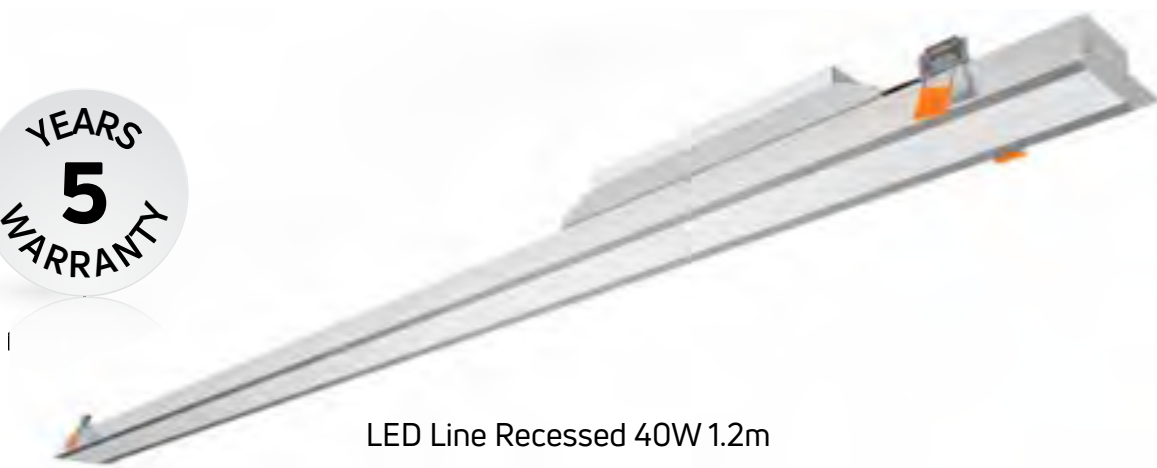

LED Line Recessed 40W 1.2m



CODE		WATT	CCT	LUMEN	
LLRT-1.2WD	●	40	3000	4000	1/12
LLRT-1.2CD	●	40	4000	4200	1/12
LLRT-1.2WDB	●	40	3000	4000	1/12
LLRT-1.2CDB	●	40	4000	4200	1/12

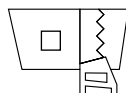

Cut Hole:
1185 x 47 mm

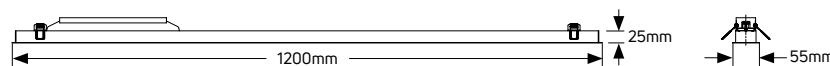

Architectural Illumination

Linear Lights

LED Line Recessed



LED Line Recessed 50W 1.5m



CODE		WATT	CCT	LUMEN	
LLRT-1.5WD	●	50	3000	5000	1/12
LLRT-1.5CD	●	50	4000	5250	1/12
LLRT-1.5WDB	●	50	3000	5000	1/12
LLRT-1.5CDB	●	50	4000	5250	1/12

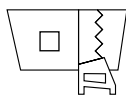

Cut Hole:
1485 x 47 mm

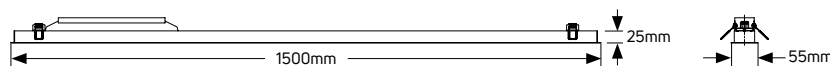

PC Cover

CODE	DESCRIPTION	
LLR5	PC Cover for Line Recessed 5M/roll	1/12

Spots





GU10 MAX 25W

CODE	DESCRIPTION	
SP60N	Round spot Chrome for GU10	1/100

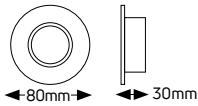

GU10 MAX 25W

CODE	DESCRIPTION	
SP60NM	Round spot Satin for GU10	1/100

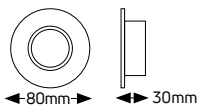

GU10 MAX 25W

CODE	DESCRIPTION	
SP60W	Round spot White for GU10	1/100

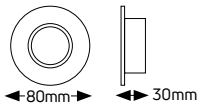

GU10 MAX 25W

CODE	DESCRIPTION	
SP60BL	Round spot Black for GU10	1/100

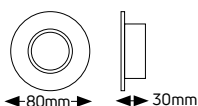

GU10 MAX 25W

CODE	DESCRIPTION	
SP60G	Round spot Gold for GU10	1/100



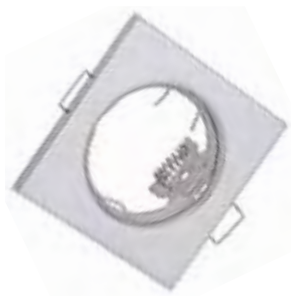

GU10 **MAX 25W**

CODE	DESCRIPTION	
SPS60N	Square spot Chrome for GU10	1/100

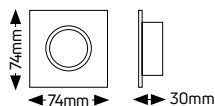

GU10 **MAX 25W**

CODE	DESCRIPTION	
SPS60NM	Square spot Satin for GU10	1/100

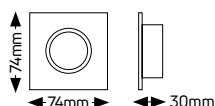

GU10 **MAX 25W**

CODE	DESCRIPTION	
SPS60W	Square spot White for GU10	1/100

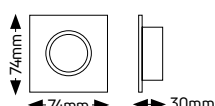

GU10 **MAX 25W**

CODE	DESCRIPTION	
SPS60BL	Square spot Black for GU10	1/100

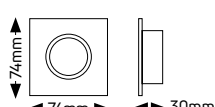

GU10 **MAX 25W**

CODE	DESCRIPTION	
SPS60G	Square spot Gold for GU10	1/100

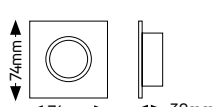



GU10 **MAX 25W**

CODE	DESCRIPTION	
SP78MN	Adjustable round spot Chrome for GU10	1/100

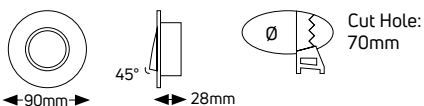

GU10 **MAX 25W**

CODE	DESCRIPTION	
SP78MNM	Adjustable round spot Satin for GU10	1/100

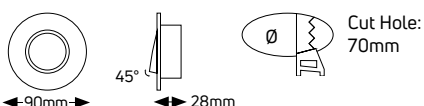

GU10 **MAX 25W**

CODE	DESCRIPTION	
SP78MW	Adjustable round spot White for GU10	1/100

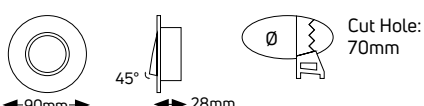

GU10 **MAX 25W**

CODE	DESCRIPTION	
SP78MBL	Adjustable round spot Black for GU10	1/100

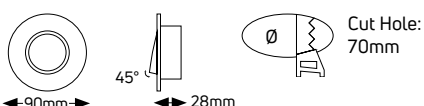

GU10 **MAX 25W**

CODE	DESCRIPTION	
SP78MG	Adjustable round spot Gold for GU10	1/100

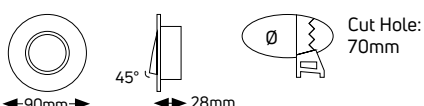

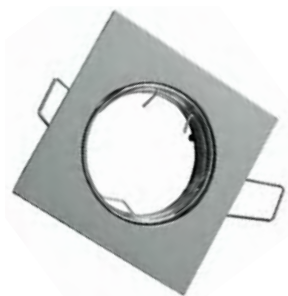

GU10 **MAX 25W**

CODE	DESCRIPTION	
SPS78MN	Adjustable square spot Chrome for GU10	1/100

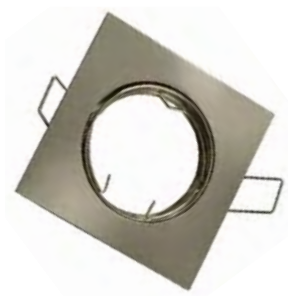
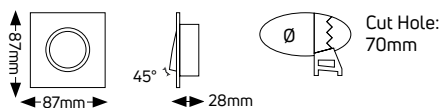

GU10 **MAX 25W**

CODE	DESCRIPTION	
SPS78MNM	Adjustable square spot Satin for GU10	1/100

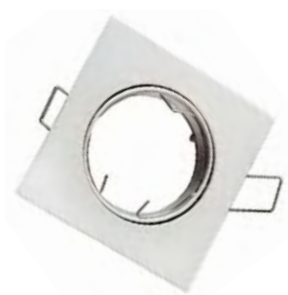
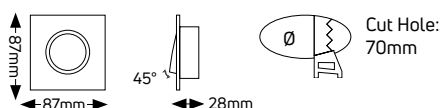

GU10 **MAX 25W**

CODE	DESCRIPTION	
SPS78MW	Adjustable square spot White for GU10	1/100

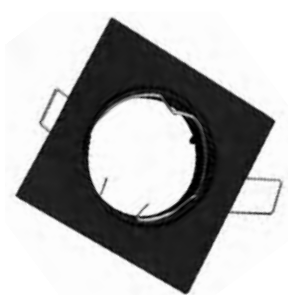
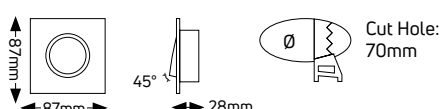

GU10 **MAX 25W**

CODE	DESCRIPTION	
SPS78MBL	Adjustable square spot Black for GU10	1/100

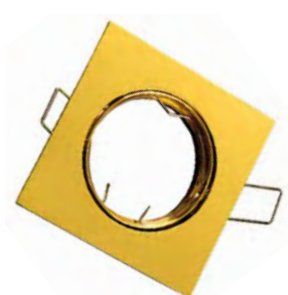
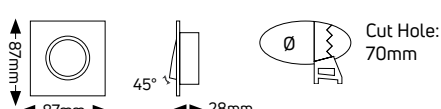

GU10 **MAX 25W**

CODE	DESCRIPTION	
SPS78MG	Adjustable square spot Gold for GU10	1/100

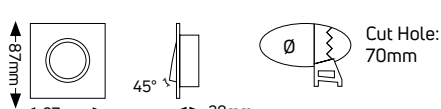

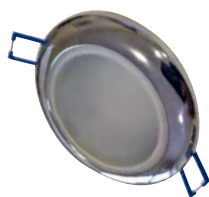

IP54 GU10 MAX 25W

CODE		DESCRIPTION	
SPW75MW	○	White Spot	1/100
SPW75MN	●	Chrome Spot	1/100
SPW75MNM	●	Nikel Spot	1/100



IP20 GU10 MAX 25W

CODE		DESCRIPTION	
SPR65B	●	Round spot R65	1/100
SPR65W	○	Round spot R65	1/100

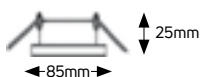

IP44 GU10 MAX 25W

CODE		DESCRIPTION	
SPR44G65B	●	Round spot R65	1/50
SPR44G65W	○	Round spot R65	1/50



IP20 GU10 MAX 25W

CODE		DESCRIPTION	
SPRAC65B	●	Round spot AC65	1/100
SPRAC65W	○	Round spot AC65	1/100

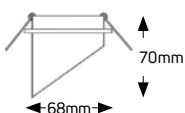



IP20 GU10 UGR<16 MAX 25W

CODE		DESCRIPTION	
SPRA65B	●	Round spot A65 UGR<16	1/100
SPRA65W	○	Round spot A65 UGR<16	1/100

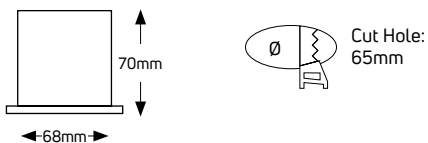

IP20 GU10 MAX 25W

CODE		DESCRIPTION	
SPS65B	●	Square spot S65	1/100
SPS65W	○	Square spot S65	1/100

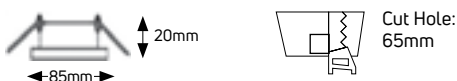

IP44 GU10 MAX 25W

CODE		DESCRIPTION	
SPS44G65B	●	Square spot G75	1/100
SPS44G65W	○	Square spot G75	1/100



IP20 GU10 MAX 25W

CODE		DESCRIPTION	
SPSG65B	●	Square spot G75	1/100
SPSG65W	○	Square spot G75	1/100

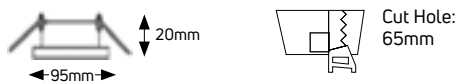

IP20 GU10 MAX 25W



CODE	DESCRIPTION	
FW60180GU10B ●	Surface spot	1/40
FW60180GU10W ○	Surface spot	1/40

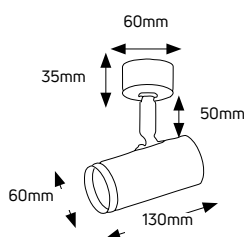

YEARS
5
WARRANTY



36° IP40 RA ≥90 PF>0.9 ENERGY CLASS A+ 10,000h +25/-5°C

CODE	WATT	CCT	LUMEN	
LWAS15WB ●	15	3000	1450	1/12
LWAS15CB ●	15	4000	1450	1/12
LWAS15WW ○	15	3000	1450	1/12
LWAS15CW ○	15	4000	1450	1/12

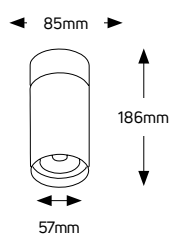

Architectural Illumination

YEARS
5
WARRANTY



CODE		WATT	CCT	LUMEN	
LWAS25WB	●	25	3000	2350	1/12
LWAS25CB	●	25	4000	2350	1/12
LWAS25WW	○	25	3000	2350	1/12
LWAS25CW	○	25	4000	2350	1/12

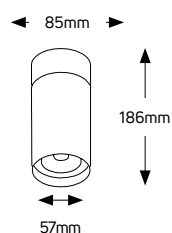

Architectural Illumination





IP20 GU10 MAX 25W

CODE		DESCRIPTION	
SPR8084B	●	Surface round spot adjustable	1/40
SPR8084W	○	Surface round spot adjustable	1/40

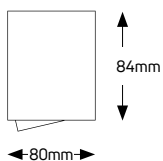

IP20 GU10 MAX 25W

CODE		DESCRIPTION	
SPR85115B	●	Surface round spot adjustable	1/30
SPR85115W	○	Surface round spot adjustable	1/30

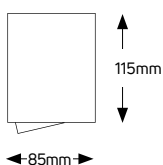

IP20 GU10 MAX 25W

CODE		DESCRIPTION	
SPR96125B	●	Surface round spot adjustable	1/20
SPR96125W	○	Surface round spot adjustable	1/20

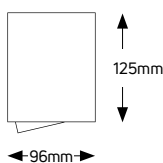

IP20 GU10 MAX 2x25W

CODE		DESCRIPTION	
SPR96125DB	●	Surface round double spot adjustable	1/10
SPR96125DW	○	Surface round double spot adjustable	1/10

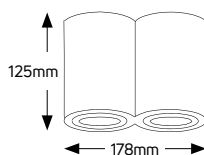



IP20 GU10 MAX 25W

CODE		DESCRIPTION	
SPS8084B	●	Surface square spot adjustable	1/40
SPS8084W	○	Surface square spot adjustable	1/40

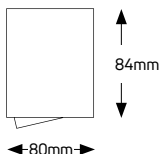

IP20 GU10 MAX 25W

CODE		DESCRIPTION	
SPS96125B	●	Surface square spot adjustable	1/20
SPS96125W	○	Surface square spot adjustable	1/20

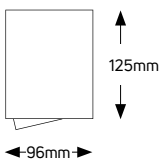

IP20 GU10 MAX 2x25W

CODE		DESCRIPTION	
SPS96125DB	●	Surface square double spot adjustable	1/10
SPS96125DW	○	Surface square double spot adjustable	1/10

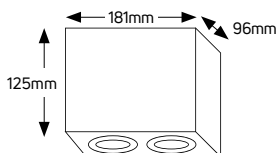

Spot R70

IP20 GU10 MAX 16W



CODE		DESCRIPTION	
SPR70100B	●	Surface round spot R70	1/20
SPR70100W	○	Surface round spot R70	1/20

Ring is not included

Spot R70

IP20 GU10 MAX 16W



CODE		DESCRIPTION	
R70B	●	Ring for R70	1
R70W	○	Ring for R70	1
R70Y	●	Ring for R70	1



Spot Trio70

IP20 GU10 MAX 25W



CODE		DESCRIPTION	
SPR70140B	●	Surface round spot Trio70S	1/30
SPR70140W	○	Surface round spot Trio70S	1/30

Ring is not included

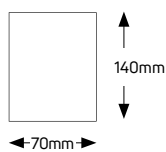

Spot Trio70

IP20 GU10 MAX 25W



CODE		DESCRIPTION	
SPR70254B	●	Surface round spot Trio70L	1/20
SPR70254W	○	Surface round spot Trio70L	1/20

Ring is not included

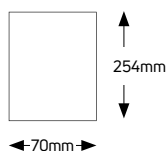

Spot Trio70

IP20 GU10 MAX 25W



CODE		DESCRIPTION	
TR70B	●	Ring for Trio70	1
TR70W	○	Ring for Trio70	1
TR70S	●	Ring for Trio70	1
TR70G	●	Ring for Trio70	1
TR70Y	●	Ring for Trio70	1

Spot Trio90

IP20 GU10 MAX 25W



CODE		DESCRIPTION	
SPR90140B	●	Surface round spot Trio90S	1/30
SPR90140W	○	Surface round spot Trio90S	1/30

Ring is not included

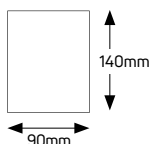

Spot Trio90

IP20 GU10 MAX 25W



CODE		DESCRIPTION	
SPR90254B	●	Surface round spot Trio90L	1/20
SPR90254W	○	Surface round spot Trio90L	1/20

Ring is not included

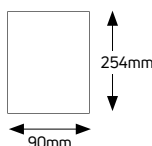

Spot Trio90

IP20 GU10 MAX 25W



CODE		DESCRIPTION	
TR90B	●	Ring for Trio90	1
TR90W	○	Ring for Trio90	1
TR90S	●	Ring for Trio90	1
TR90G	●	Ring for Trio90	1
TR90Y	●	Ring for Trio90	1

IP54 GU10 MAX 25W



CODE		DESCRIPTION	
SPR6588B	●	Surface round spot R65	1/50
SPR6588W	○	Surface round spot R65	1/50

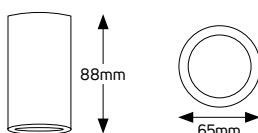



IP20 GU10 MAX 25W

CODE		DESCRIPTION	
SPR6595B	●	Surface round spot	1/50
SPR6595W	○	Surface round spot	1/50

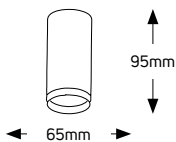

IP20 GU10 MAX 25W

CODE		DESCRIPTION	
FS60130GU10B	●	Surface round spot	1/40
FS60130GU10W	○	Surface round spot	1/40

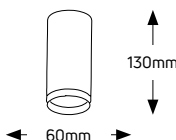

IP20 GU10 MAX 25W UGR<16

CODE		DESCRIPTION	
SPRA85115B	●	Surface round spot RA85	1/30
SPRA85115W	○	Surface round spot RA85	1/30

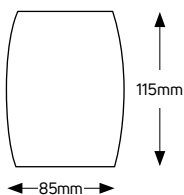

IP20 GU10 MAX 25W UGR<16

CODE		DESCRIPTION	
SPR75UB	●	Round spot R75 UGR<16	1/100
SPR75UW	○	Round spot R75 UGR<16	1/100





IP20 GU10 MAX 25W

CODE		DESCRIPTION	
SPR56130B	●	Surface round spot R56	1/50
SPR56130W	○	Surface round spot R56	1/50

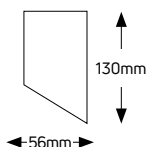

IP20 GU10 MAX 25W

CODE		DESCRIPTION	
SPR80130B	●	Surface round spot R80	1/40
SPR8013W	○	Surface round spot R80	1/40

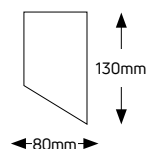

IP20 GU10 MAX 25W

CODE		DESCRIPTION	
SPS80130B	●	Surface square spot S80	1/40
SPS80130W	○	Surface square spot S80	1/40

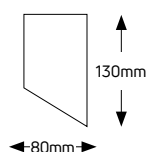



IP20 GU10

CODE		DESCRIPTION	
SPS111B	●	Recessed square spot 1xR111	1/60
SPS111W	○	Recessed square spot 1xR111	1/60



IP20 GU10

CODE		DESCRIPTION	
SPS112B	●	Recessed square spot 2xR111	1/40
SPS112W	○	Recessed square spot 2xR111	1/40

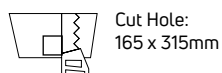

IP20 GU10

CODE		DESCRIPTION	
SPS113B	●	Recessed square spot 3xR111	1/30
SPS113W	○	Recessed square spot 3xR111	1/30



Gypsum Lights





CLASS II GU10

CODE	DESCRIPTION	
FGC100R	Gypsum round spot	1/30

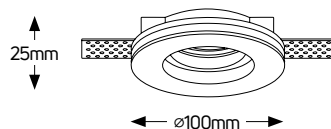

CLASS II GU10

CODE	DESCRIPTION	
FGS100R	Gypsum square spot	1/30

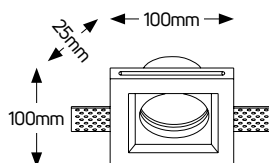

CLASS II GU10

CODE	DESCRIPTION	
FGS120R1	Gypsum square spot	1/24

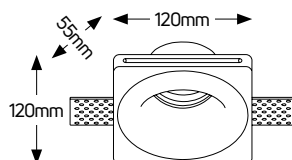



CLASS II GU10

CODE	DESCRIPTION	
FGC130R	Gypsum round spot	1/24

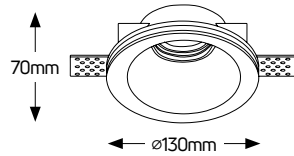

CLASS II GU10

CODE	DESCRIPTION	
FGSQ120R2	Gypsum square spot single	1/24

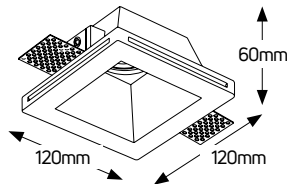

CLASS II 2x GU10

CODE	DESCRIPTION	
FG215125R2	Gypsum spot double	1/12

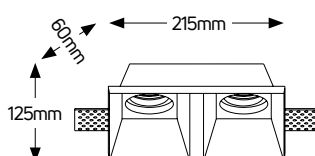



CLASS II GU10

CODE	DESCRIPTION	
FGS170AR	Gypsum square spot adjustable single	1/8

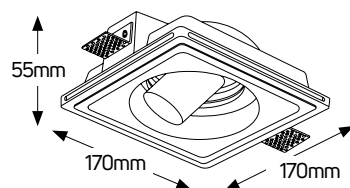

CLASS II 2x GU10

CODE	DESCRIPTION	
FG320170AR	Gypsum spot adjustable double	1/4

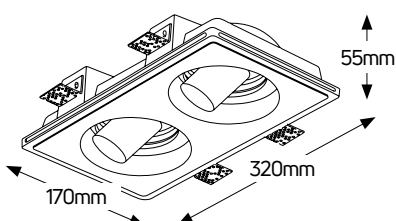



CLASS II GU10

CODE	DESCRIPTION	
FGSQ80R	Gypsum square spot single	1/24

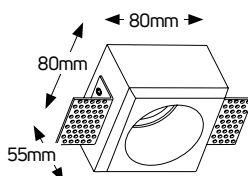

CLASS II 2x GU10



CODE	DESCRIPTION	
FG15080R	Gypsum spot double	1/20

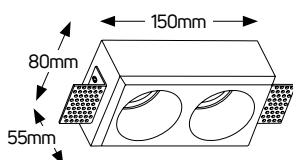

CLASS II 3x GU10



CODE	DESCRIPTION	
FG20080R	Gypsum spot triple	1/20

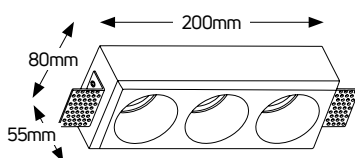



CLASS II GU10

CODE	DESCRIPTION	
FGS190R	Gypsum square spot 1xR111	1/8

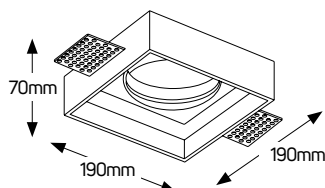

CLASS II 2x GU10

CODE	DESCRIPTION	
FG350190R	Gypsum spot 2xR111	1/4

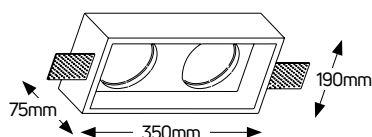

CLASS II 3x GU10

CODE	DESCRIPTION	
FG460190R	Gypsum spot 3xR111	1/4

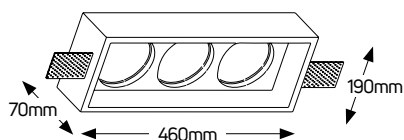



CLASS II GU10

CODE	DESCRIPTION	
FGC7090SM	Gypsum round ceiling spot	1/20

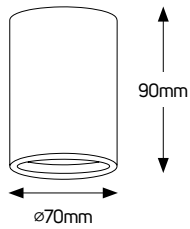

CLASS II GU10

CODE	DESCRIPTION	
FGC70170SM	Gypsum round ceiling spot	1/12

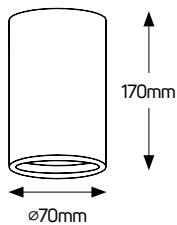

CLASS II GU10

CODE	DESCRIPTION	
FGS7090SM	Gypsum square ceiling spot	1/20

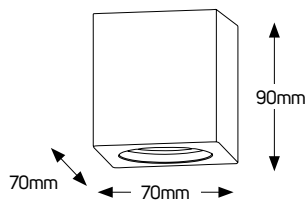



CLASS II GU10

CODE	DESCRIPTION	
FGS70170SM	Gypsum square ceiling spot	1/2

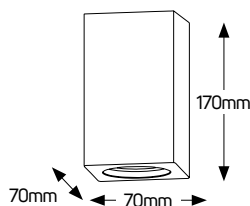

CLASS I 3x GU10

CODE	DESCRIPTION	
FGS240150SM	Gypsum 3x square ceiling spot	1/6

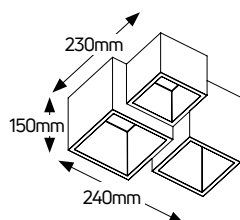

CLASS I 5x GU10

CODE	DESCRIPTION	
FGS370150SM	Gypsum 5x square ceiling spot	1/6

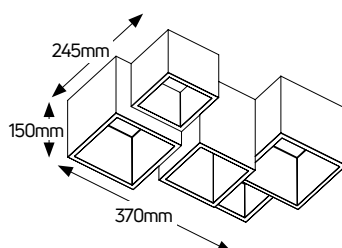



CLASS I 2x GU10

CODE	DESCRIPTION	
FGS310250UD	Gypsum square spot up-down	1/6

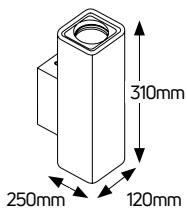

CLASS I 2x GU10

CODE	DESCRIPTION	
FGC310250UD	Gypsum round spot up-down	1/6

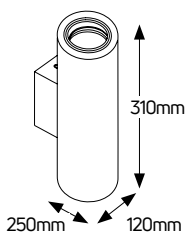

CLASS II GU10

CODE	DESCRIPTION	
FGC245110W	Gypsum steplight	1/2

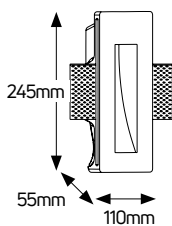



CLASS II GU10

CODE	DESCRIPTION	
FG245110W	Gypsum tear steplight	1/8

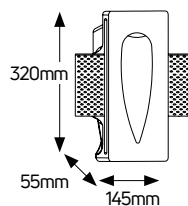

CLASS II GU10

CODE	DESCRIPTION	
FGC180120W	Gypsum round steplight	1/24

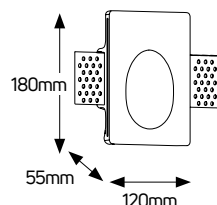

CLASS II GU10

CODE	DESCRIPTION	
FGS120W	Gypsum square steplight	1/8

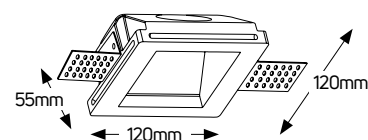



CLASS
I

CODE	DESCRIPTION	
LGC150W	LED Gypsum 5W 3000K round	1/8

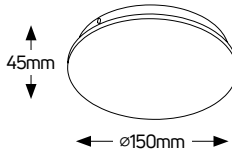

CLASS
I

CODE	DESCRIPTION	
LGC250W	LED Gypsum 11W 3000K round	1/8

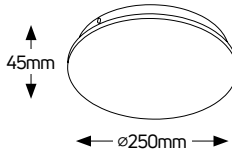

CLASS
I

CODE	DESCRIPTION	
LGC300W	LED Gypsum 14W 3000K round	1/4

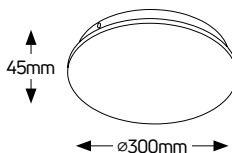



CLASS
I

CODE	DESCRIPTION	
LGS150W	LED Gypsum 7W 3000K square	1/8

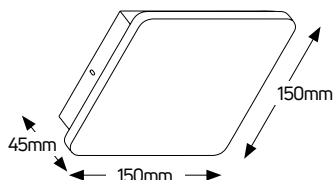

CLASS
I

CODE	DESCRIPTION	
LGS250W	LED Gypsum 14W 3000K square	1/8

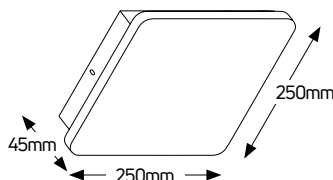

CLASS
I

CODE	DESCRIPTION	
LGS300W	LED Gypsum 18W 3000K square	1/4

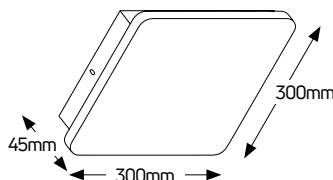



CLASS
I

G9

CODE	DESCRIPTION	
FGS100UD	Gypsum square up-down	1/2

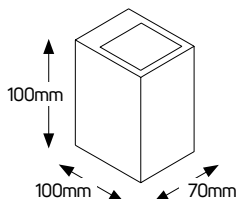

CLASS
I

G9

CODE	DESCRIPTION	
FGS10070UD	Gypsum round up-down	1/6

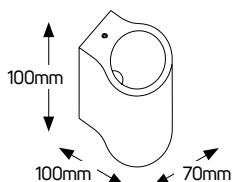

CLASS
I

G9

CODE	DESCRIPTION	
FGR230120WL	Gypsum round up-down DOT	1/6

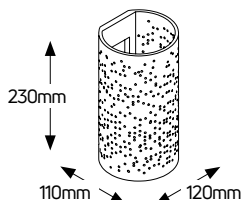



CLASS I G9

CODE	DESCRIPTION	
FGS120WL	Gypsum square up-down DOT	1/6

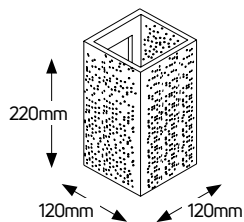

CLASS I G9

CODE	DESCRIPTION	
FGS160100UD	Gypsum square up-down	1/12

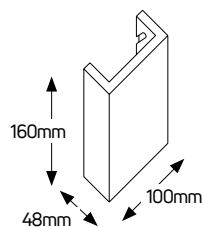

CLASS I G9

CODE	DESCRIPTION	
FGR160100UD	Gypsum curved up-down	1/12

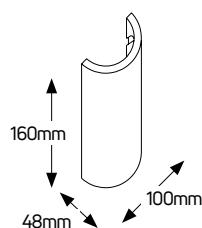



CLASS I E14

CODE	DESCRIPTION	
FGR235185WL	Gypsum curved	1/6

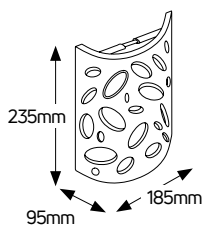

CLASS I G9

CODE	DESCRIPTION	
FGR150120UD	Gypsum DOT ball	1/12

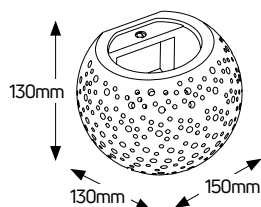

CLASS I E14

CODE	DESCRIPTION	
FGA300170WL	Gypsum up-down	1/4

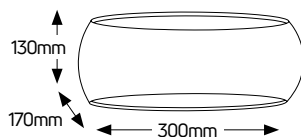



CLASS I E14

CODE	DESCRIPTION	
FGA370170WL	Gypsum wall mounted up-down round	1/4

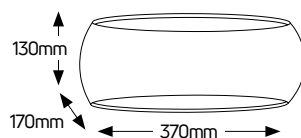

CLASS I G9

CODE	DESCRIPTION	
FGA20085UD	Gypsum curved up-down	1/12

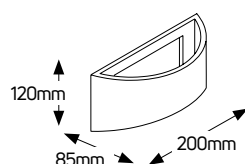

CLASS I E14

CODE	DESCRIPTION	
FGA280140U	Gypsum wall mounted up	1/6

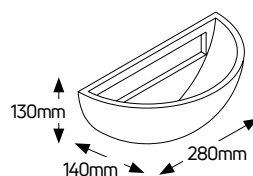

CLASS I E14

CODE	DESCRIPTION	
FGA245120UD	Gypsum wall mounted up-down	1/6

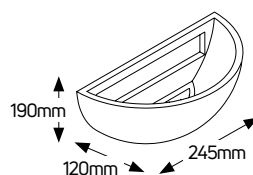



CLASS
I

G9

CODE	DESCRIPTION	
FGA36095UD	Gypsum Recta up-down glass	1/6

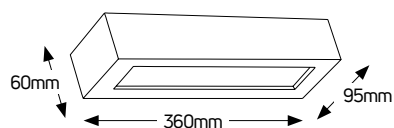

CLASS
I

E14

CODE	DESCRIPTION	
FG300120WL	Gypsum wall mounted oval	1/4

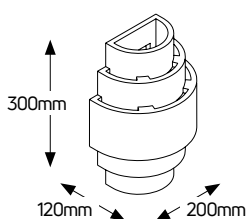

CLASS
I

G9

CODE	DESCRIPTION	
FG180105WL	Gypsum wall mounted square	1/4

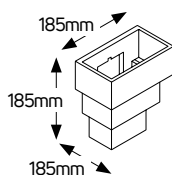



CLASS I 2x G9

CODE	DESCRIPTION	
FGA35375U	Gypsum Recta up	1/8

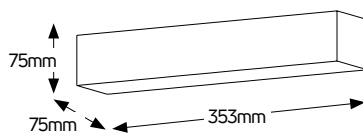

CLASS I 2x G9

CODE	DESCRIPTION	
FGA35375UD	Gypsum Recta up-down	1/8

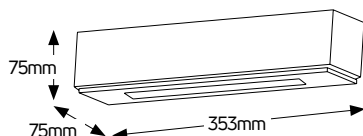

CLASS I E14

CODE	DESCRIPTION	
FGA300105UD	Gypsum wall mounted up-down glass	1/6

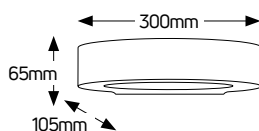

Pendant Lights



Pendant Lights

GEYER



● Black

CODE	WATT	CCT	LUMEN	
LPBW3025W	25	3000	1850	1/10
LPBW4035W	35	3000	2920	1/6

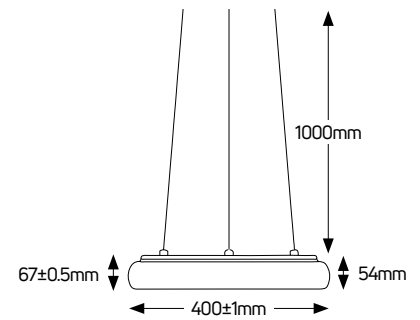
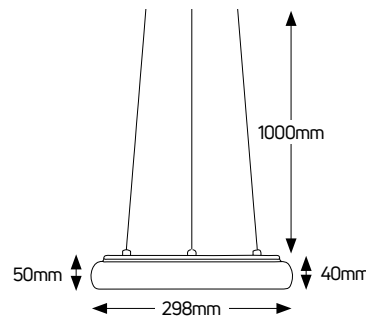

Architectural Illumination



CODE		DESCRIPTION	
FP60130GU10B	●	Pendant spot with 2.5m cable	1/40
FP60130GU10W	○	Pendant spot with 2.5m cable	1/40

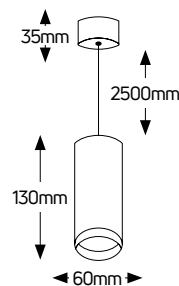

E27



CODE	DESCRIPTION	
PBI3030E27	Pendant Iron 2.5m cable	1

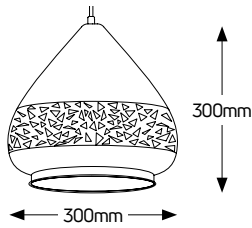

E27



CODE	DESCRIPTION	
PGI2525E27	Pendant Iron 2.5m cable	1

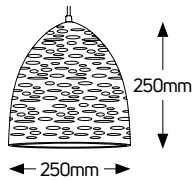

E27



CODE	DESCRIPTION	
PGI2040E27	Pendant Iron 2.5m cable	1

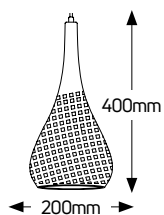



E27

CODE		DESCRIPTION	
PBI2020E27	●	Pendant Iron 2.5m cable	1
PGI2020E27	●	Pendant Iron 2.5m cable	1

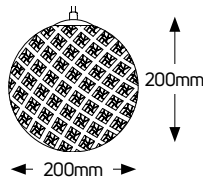

E27

CODE		DESCRIPTION	
PGI1330E27	●	Pendant Iron 2.5m cable	1

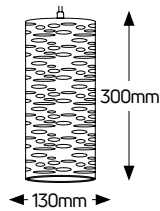

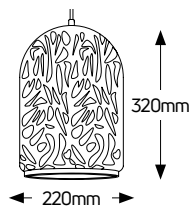

E27

CODE		DESCRIPTION	
PBI2233E27	●	Pendant Iron 2.5m cable	1



E27



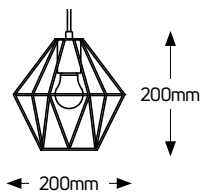

CODE		DESCRIPTION	
PRGI225E27		Pendant Iron 2.5m cable	1
PBI225E27		Pendant Iron 2.5m cable	1



E27



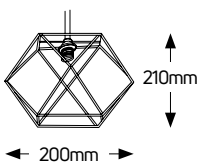

CODE		DESCRIPTION	
PBIS2021		Pendant Iron+Glass 2.5m cable	1
PBIA2021		Pendant Iron+Glass 2.5m cable	1



E27



CODE		DESCRIPTION	
PBIS1015		Pendant Iron+Glass 2.5m cable	1
PBIA1015		Pendant Iron+Glass 2.5m cable	1

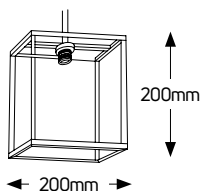

E27



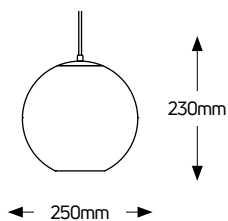

CODE	DESCRIPTION	
PRGI2525E27 	Pendant Iron 2.5m cable	1
PWI2525E27 	Pendant Iron 2.5m cable	1



E27



CODE	DESCRIPTION	
PRGI3025E27 	Pendant Iron 2.5m cable	1

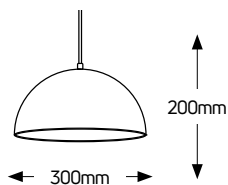

E27



CODE		DESCRIPTION	
PBP1725E27	●	Pendant Iron 2.5m cable	1
PWP1725E27	○	Pendant Iron 2.5m cable	1

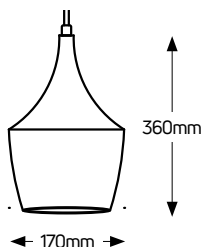

E27



CODE		DESCRIPTION	
PBP3625E27	●	Pendant Iron 2.5m cable	1
PWP3625E27	○	Pendant Iron 2.5m cable	1

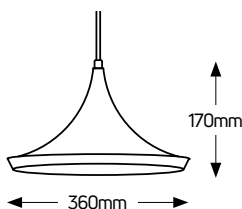

E27



CODE		DESCRIPTION	
PBP1925E27	●	Pendant Iron 2.5m cable	1
PWP1925E27	○	Pendant Iron 2.5m cable	1

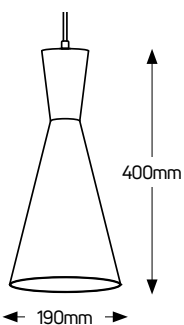

E27



CODE

DESCRIPTION



PBP2528E27



Pendant Brown Paper 2.5m cable

1

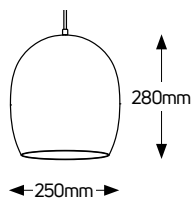

E27



CODE

DESCRIPTION



PBP3121E27



Pendant Brown Paper 2.5m cable

1

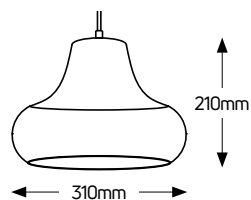

E27



CODE

DESCRIPTION



PBP4017E27



Pendant Brown Paper 2.5m cable

1

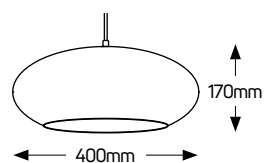

E27



CODE

DESCRIPTION



PBP2545E27



Pendant Brown Paper 2.5m cable

1

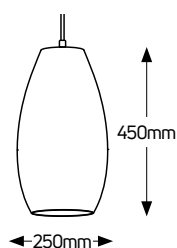

E27



CODE	DESCRIPTION	
PC150265E27	Pendant Cement 2.5m cable	1

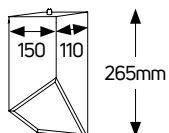

E27



CODE	DESCRIPTION	
PC120140E27	Pendant Cement 2.5m cable	1

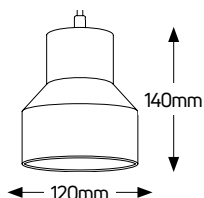

E27



CODE	DESCRIPTION	
PC185255E27	Pendant Cement 2.5m cable	1

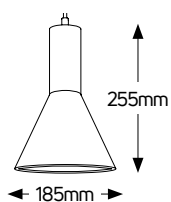



E27

CODE	DESCRIPTION	
PC100180E27	Pendant Cement 2.5m cable	1

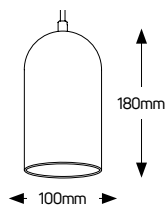

E27



CODE	DESCRIPTION	
PC270140E27	Pendant Cement 2.5m cable	1

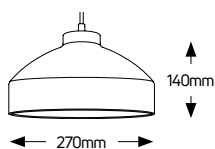

E27



CODE	DESCRIPTION	
PC170220E27	Pendant Cement 2.5m cable	1

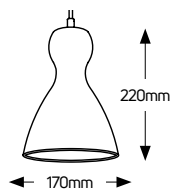



E27

CODE		DESCRIPTION	
PC6639W	○	Pendant Cement 2.5m cable	1

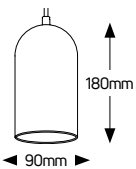

E27

CODE		DESCRIPTION	
PC6639P	●	Pendant Cement 2.5m cable	1

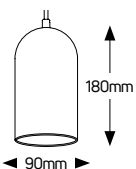

E27

CODE		DESCRIPTION	
PC6639G	●	Pendant Cement 2.5m cable	1

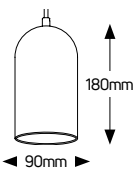

E27

CODE		DESCRIPTION	
PC6639B	●	Pendant Cement 2.5m cable	1

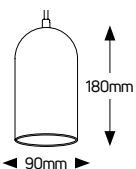

E27



CODE		DESCRIPTION	
PC6640W		Pendant Cement 2.5m cable	1

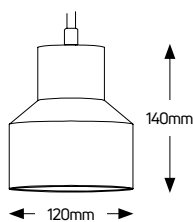

E27



CODE		DESCRIPTION	
PC6640G		Pendant Cement 2.5m cable	1

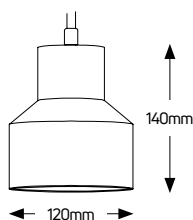

E27



CODE		DESCRIPTION	
PC6640B		Pendant Cement 2.5m cable	1

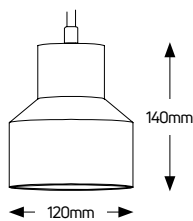



GU10

CODE		DESCRIPTION	
PC6641G	●	Pendant Cement 2.5m cable	1

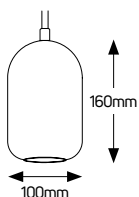

GU10

CODE		DESCRIPTION	
PC6641W	○	Pendant Cement 2.5m cable	1

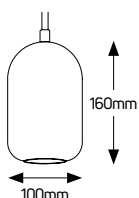

GU10

CODE		DESCRIPTION	
PC6641B	●	Pendant Cement 2.5m cable	1

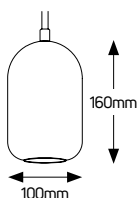



E27

CODE	DESCRIPTION	
PC6643W	Pendant Cement 2.5m cable	1

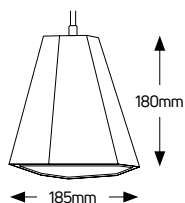

E27

CODE	DESCRIPTION	
PC6643G	Pendant Cement 2.5m cable	1

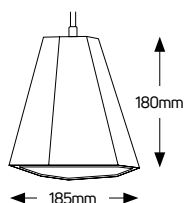

E27

CODE	DESCRIPTION	
PC6643P	Pendant Cement 2.5m cable	1

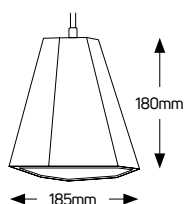



E27

CODE	DESCRIPTION	
PC6644P	Pendant Cement 2.5m cable	1

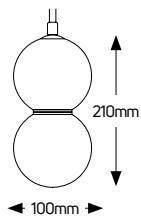

E27

CODE	DESCRIPTION	
PC6644G	Pendant Cement 2.5m cable	1

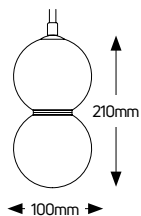

E27

CODE	DESCRIPTION	
PC6644W	Pendant Cement 2.5m cable	1

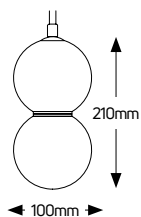

E27



CODE	DESCRIPTION	
PC6646W	Pendant Cement 2.5m cable	1

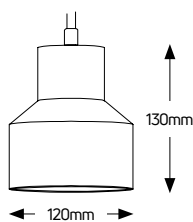

E27



CODE	DESCRIPTION	
PC6646B	Pendant Cement 2.5m cable	1

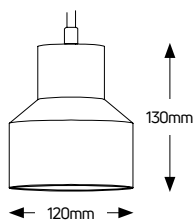

Outdoor Lights



Outdoor Lights

Bulkheads

GEYER

IP54



CODE	WATT	CCT	LUMEN	
LBL18W8	8	3000	640	1/40
LBL18C8	8	4000	640	1/40

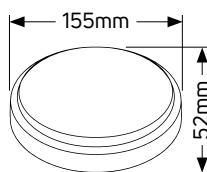

IP54



CODE	WATT	CCT	LUMEN	
LBL21W12	12	3000	960	1/40
LBL21C12	12	4000	960	1/40

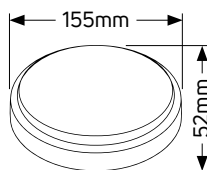

Architectural Illumination

Outdoor Lights

Bulkheads

GEYER

IP54



CODE	WATT	CCT	LUMEN	
LLOW8	8	3000	640	1/40
LBLOC8	8	4000	640	1/40

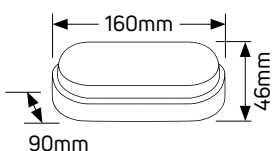

IP54



CODE	WATT	CCT	LUMEN	
LLOW12	12	3000	960	1/40
LBLOC12	12	4000	960	1/40

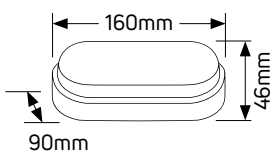

Architectural Illumination

Outdoor Lights

Ceiling Lights

GEYER

IP40



-
-
-
-
-
-
-
-

CODE	WATT	CCT	LUMEN	
LCL22W12	12	3000	800	1/10
LCL22C12	12	4000	800	1/10

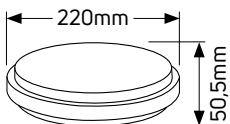

IP40



-
-
-
-
-
-
-
-

CODE	WATT	CCT	LUMEN	
LCL28W18	18	3000	1200	1/20
LCL28C18	18	4000	1200	1/20

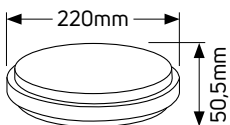

Architectural Illumination



Outdoor Lights

Ceiling Lights

IP65



CODE	WATT	CCT	LUMEN	
LCL220W15	15	3000	1250	1/20
LCL220C15	15	4000	1250	1/20

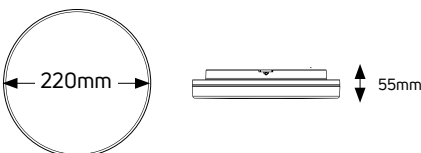

IP65



CODE	WATT	CCT	LUMEN	
LCL280W18	18	3000	1500	1/10
LCL280C18	18	4000	1500	1/10

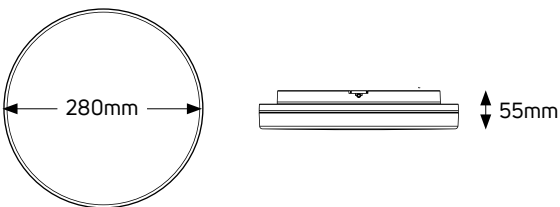

IP65



CODE	WATT	CCT	LUMEN	
LCL330W24	24	3000	2050	1/6
LCL330C24	24	4000	2050	1/6

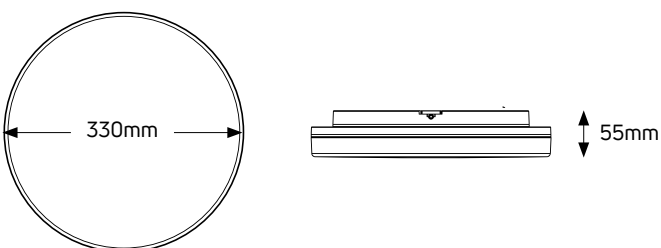

Outdoor Lights

Wall Lights

GEYER

IP54 MAX 15W YEARS 2 WARRANTY



CODE	WATT	CCT	LUMEN	
FOWL90303DG	● E27	13,67	1/20	1/20

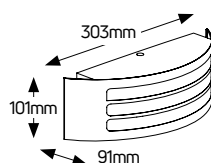

IP54 MAX 25W YEARS 2 WARRANTY



CODE	WATT	CCT	LUMEN	BASE	
LOWS106165WDG	● 6	3000	250	-	1/28
FOWS106165DG	● -	-	-	E27	1/10

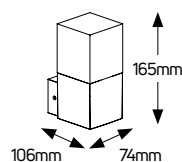

IP54 YEARS 2 WARRANTY

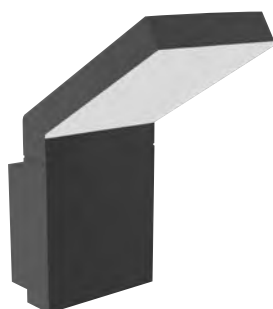

CODE	WATT	CCT	LUMEN	
LOWS146178WDG	● 6	3000	250	1/12

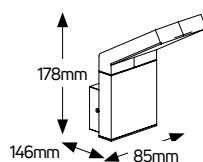

Architectural Illumination

Outdoor Lights

Wall Lights

GEYER



IP54 **2 YEARS WARRANTY**

CODE	WATT	CCT	LUMEN	
LOWS18050WDG ●	6	3000	250	1/20

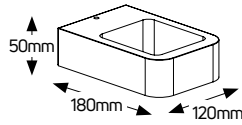

IP54 **MAX 25W** **2 YEARS WARRANTY**

CODE	WATT	CCT	LUMEN	
FOWR145220DG ●	E27	34,93	1/12	1/20

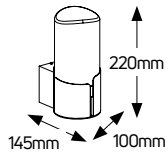

IP54 **2 YEARS WARRANTY**

CODE	WATT	CCT	LUMEN	
LOWL90120WDG ●	6	3000	250	1/20

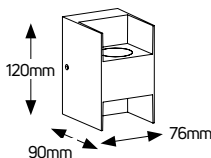

Architectural Illumination

Outdoor Lights

Wall Lights

GEYER

Architectural Illumination



CODE	WATT	CCT	LUMEN	
LOWL80240WDG ●	6	3000	250	1/10

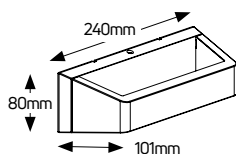

CODE	WATT	CCT	LUMEN	
LOWL62235WDG ●	6	3000	250	1/25

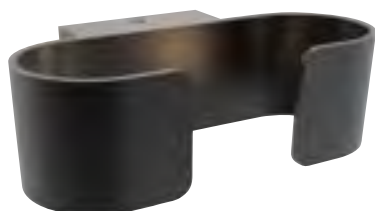
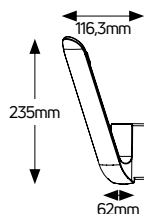

CODE	WATT	CCT	LUMEN	
LOWL200123WW ○	6	3000	250	1/10
LOWL200123WDG ●	6	3000	250	1/10

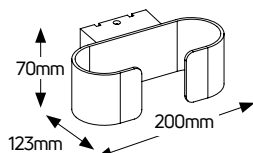

Outdoor Lights

Wall Lights

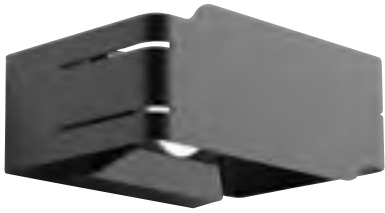

IP65 MAX 18W YEARS 2 WARRANTY

CODE		BASE	
FOWL70160W		G9	1/20
FOWL70160DG		G9	1/20

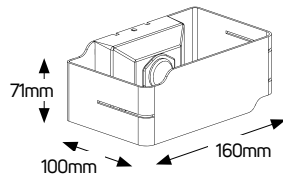

IP54 MAX 16W YEARS 2 WARRANTY

CODE		BASE	
FOWR100146DG		GU10	1/20

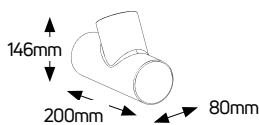



CODE		WATT	CCT	LUMEN	
LOWP12583WW	○	12	3000	110	1/40
LOWP12586WSG	●	12	3000	110	1/40

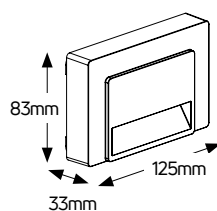

CODE		WATT	CCT	LUMEN	
LOWS125125WSG	●	12	3000	110	1/40
LOWS125125WDG	●	12	3000	110	1/40

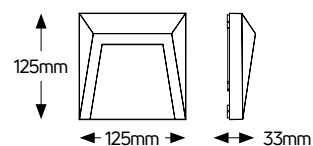

CODE		WATT	CCT	LUMEN	
LOWS23080WSG	●	16	3000	140	1/24
LOWP23080WDG	●	16	3000	140	1/24

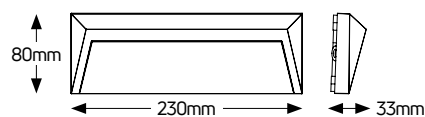

Outdoor Lights

Step Lights



CODE	WATT	CCT	LUMEN	
SL70F1W	1	3000	60	1/50

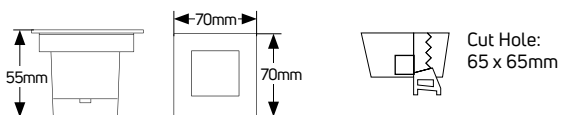

CODE	WATT	CCT	LUMEN	
SL70L1W	1	3000	60	1/50

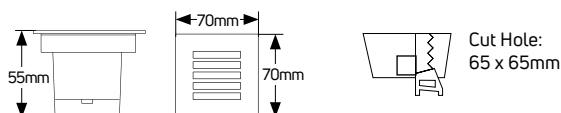

CODE	WATT	CCT	LUMEN	
SL70T1W	1	3000	60	1/50

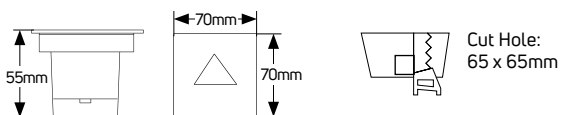



Outdoor Lights

Step Lights



CODE	WATT	CCT	LUMEN	
SL70V1W	1	3000	60	1/50

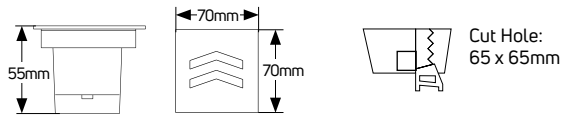

CODE	WATT	CCT	LUMEN	
SL105F3W	3	3000	180	1/50

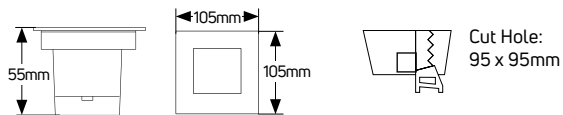

CODE	WATT	CCT	LUMEN	
SL105L3W	3	3000	180	1/50

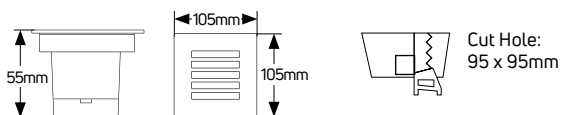

Outdoor Lights

Step Lights

GEYER



CODE	WATT	CCT	LUMEN	
SL110F3W	3	3000	180	1/50

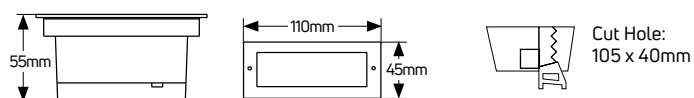

CODE	WATT	CCT	LUMEN	
SL110L3W	3	3000	180	1/50

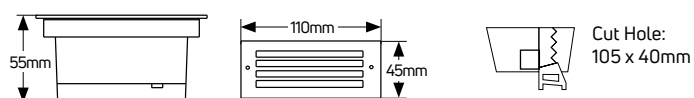

CODE	WATT	CCT	LUMEN	
SL170L3W	3	3000	180	1/50

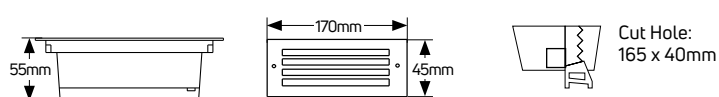

Architectural Illumination

Solar Spike wallmounted / inground 7W



CODE	WATT	WORKING TIME	CHARGE TIME	CCT	LUMEN	
SSP79C	7	9h	4.5h	4000	300/80	1

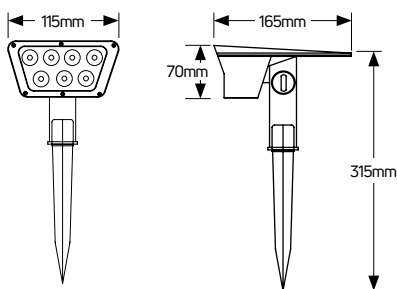

Solar Spike wallmounted / inground 12W



CODE	WATT	WORKING TIME	CHARGE TIME	CCT	LUMEN	
SSP712C	12	10h	5h	4000	300/80	1

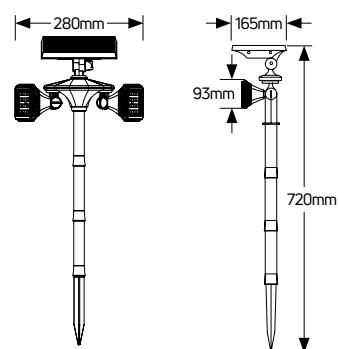

LED Spike wallmounted / inground 5W



CODE	WATT	CCT	LUMEN	
SPK42W	5	3000	300	1/50
SPK42C	5	4000	300	1/50
SPK42R	5	RED	●	1/50
SPK42B	5	BLUE	●	1/50
SPK42G	5	GREEN	●	1/50

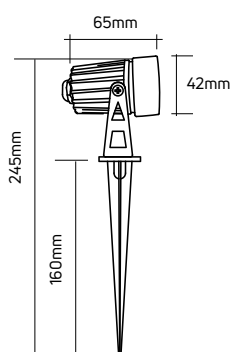

LED Spike wallmounted / inground 5W



CODE	WATT	CCT	LUMEN	
SPK60W	5	3000	300	1/50
SPK60C	5	4000	300	1/50
SPK60R	5	RED	●	1/50
SPK60B	5	BLUE	●	1/50
SPK60G	5	GREEN	●	1/50

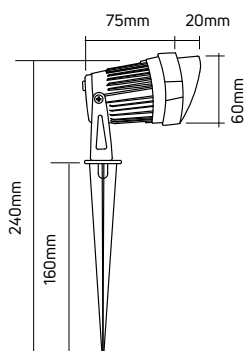

LED Spike wallmounted / inground 7W



CODE	WATT	CCT	LUMEN	
SPK75W	7	3000	420	1/50
SPK75C	7	4000	420	1/50
SPK75R	7	RED		1/50
SPK75B	7	BLUE		1/50
SPK75G	7	GREEN		1/50

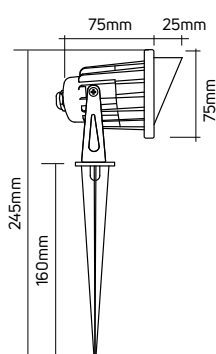

LED Spike wallmounted / inground 10W



CODE	WATT	CCT	LUMEN	
SPK85W	10	3000	700	1/20
SPK85C	10	4000	700	1/20
SPK85R	10	RED		1/20
SPK85B	10	BLUE		1/20
SPK85G	10	GREEN		1/20

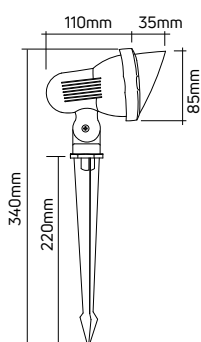

Window Light 8W



-
- IP65**
- 230-265 VAC
- 3 YEARS WARRANTY**

CODE	WATT	CCT	LUMEN	
WD8GW	8	3000	540	1/20

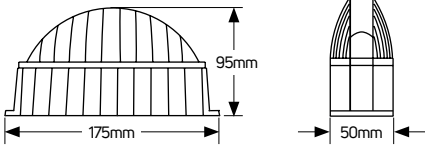

Architectural Illumination





HEIGHT
COVERAGE
7m



CODE	WATT	CCT	LUMEN	
SP10W10D	10	3000	480	1/2

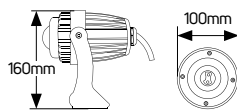

HEIGHT
COVERAGE
60m



CODE	WATT	CCT	LUMEN	
SP81W10D	81	3000	5670	1/4

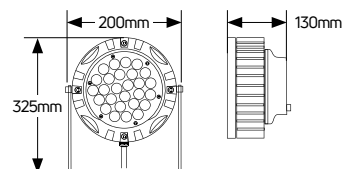

Wall Washer 9W 300mm IP65



CODE	WATT	CCT	LUMEN	
WW930W	9	3000	600	1
WW930C	9	4000	600	1

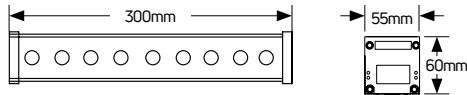

Wall Washer 18W 500mm IP65



CODE	WATT	CCT	LUMEN	
WW1850W	18	3000	1200	1
WW1850C	18	4000	1200	1

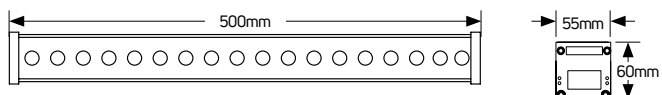

Wall Washer 36W 1000mm IP65



CODE	WATT	CCT	LUMEN	
WW36100W	36	3000	2400	1
WW36100C	36	4000	2400	1

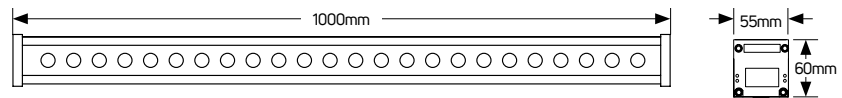

Wall Washer Recessed 36W 1000mm IP65



CODE	WATT	CCT	LUMEN	
WW930W	36	3000	2400	1
WW930C	36	4000	2400	1

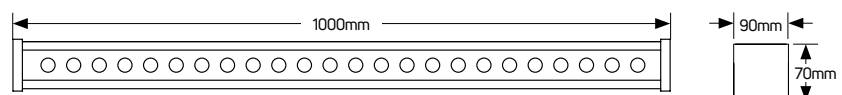

IP54 MAX 16W YEARS 2 WARRANTY



CODE		BASE	
FOCR100800DG	●	E27	1/6

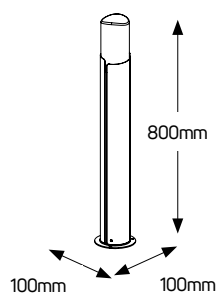

Architectural Illumination



IP54 YEARS 2 WARRANTY

CODE	WATT	CCT	LUMEN	
LOCS175800WDG	6	3000	250	1/4

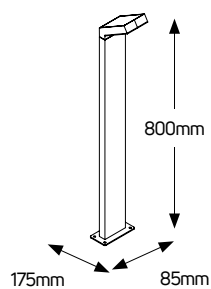

Outdoor Lights

Garden Lights

GEYER

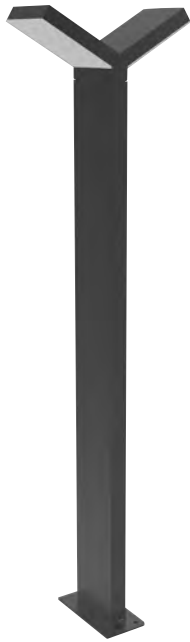

IP54
2 YEARS WARRANTY

CODE	WATT	CCT	LUMEN	
LOCS210800DW ●	2x6	3000	500	1/6

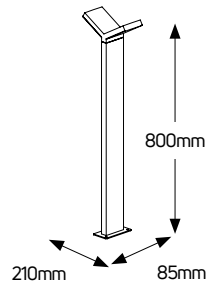

IP54
2 YEARS WARRANTY

CODE	WATT	CCT	LUMEN	
LOCBS120800WDG ●	6	3000	250	1/4

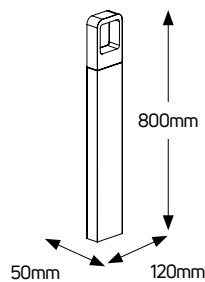

Architectural Illumination

IP54
2 YEARS WARRANTY



CODE	WATT	CCT	LUMEN	BASE	
LOCS76800WDG	6	3000	250	-	1/9
FOS76800E27	-	-	-	E27	1/9

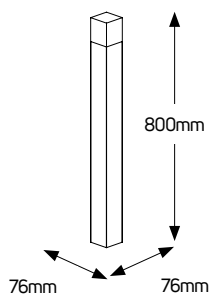

IP54
MAX 16W
E27
2 YEARS WARRANTY



CODE	BASE	
FOWR80800DG	E27	1/9

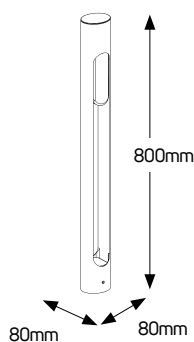

Architectural Illumination



IP54 MAX 16W GU10 YEARS 2 WARRANTY

CODE		BASE	
FOCR80600DG	●	E27	1/6

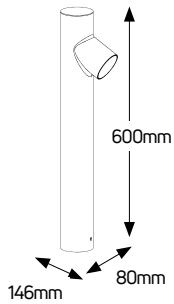

IP54 MAX 2x16W YEARS 2 WARRANTY

CODE		BASE	
FOCR80600DG2	●	2xGU10	1/6

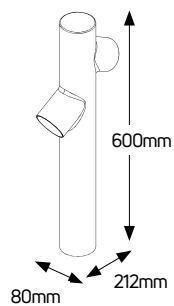



CODE	WATT	CCT	LUMEN	
LOC192800WDG ●	6	3000	250	1/6

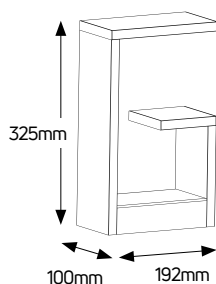

Vintage Mini



CODE	WATT	CCT	LUMEN
LPVNM.020.30	25	3000	2200
LPVNM.020.40	25	4000	2200
LPVNM.030.30	35	3000	3000
LPVNM.030.40	35	4000	3000

Lance



CODE	WATT	CCT	LUMEN
LP.LAN.040.30	45	3000	4100
LP.LAN.040.40	45	4000	4100
LP.LAN.055.30	60	3000	5400
LP.LAN.055.40	60	4000	5400

Amelia



CODE	WATT	CCT	LUMEN
LP.AML.050.30	40	3000	4900
LP.AML.050.40	40	4000	4900
LP.AML.080.30	60	3000	7900
LP.AML.080.40	60	4000	7900

Outdoor Lights

Inground Lights

GEYER



CODE	WATT	CCT	LUMEN	
LULR42W1	1	3000	60	1/100

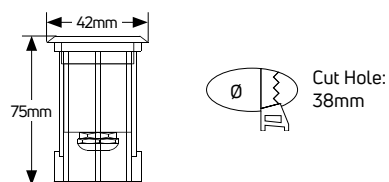

CODE	WATT	CCT	LUMEN	
LULR52W1	1	3000	60	1/100

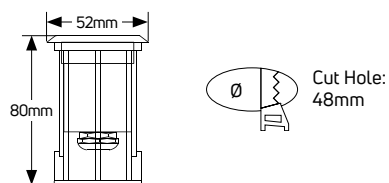

CODE	WATT	CCT	LUMEN	
LULR62W2	2	3000	90	1/100
LULR62C2	2	4000	90	1/100

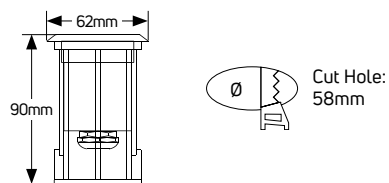

Architectural Illumination

Outdoor Lights

Inground Lights

GEYER



CODE	WATT	CCT	LUMEN	
LULS42W1	1	3000	60	1/100

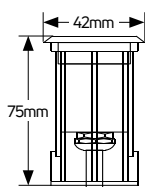

CODE	WATT	CCT	LUMEN	
LULS52W1	1	3000	60	1/100

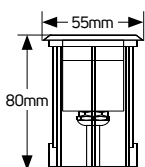

CODE	WATT	CCT	LUMEN	
LULS62W1	2	3000	90	1/100

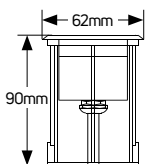

Architectural Illumination



CODE	WATT	CCT	LUMEN	
LULR62W14	1	3000	60	1/100

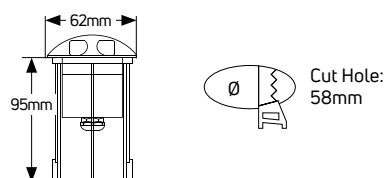

CODE	WATT	CCT	LUMEN	
LULR62W12	1	3000	60	1/100

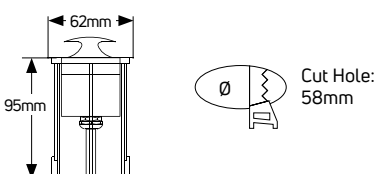

CODE	WATT	CCT	LUMEN	
LULR62W11	1	3000	60	1/100

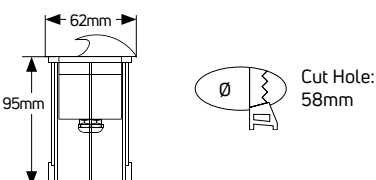



CODE	WATT	CCT	LUMEN	
LULR55W1AL	1	3000	60	1/100

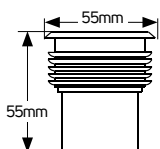

CODE	BASE	
LULR120GU10	GU10	1/100

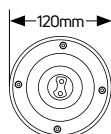
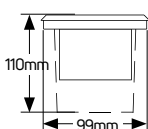

CODE	BASE	
LULS120GU10	GU10	1/100

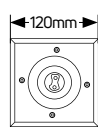
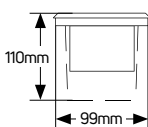



CODE	WATT	CCT	LUMEN	
LULR125W6	6	3000	300	1/100

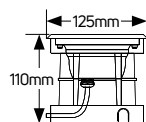

CODE	WATT	CCT	LUMEN	
LULR150W9	9	3000	540	1/100

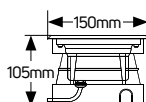

CODE	WATT	CCT	LUMEN	
LULR180W12	12	3000	720	1/100

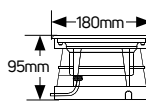

CODE	WATT	CCT	LUMEN	
LULR210W18	18	3000	1000	1/100

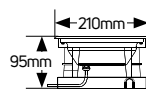

Sports Lights Stadium & Arena



Himor



CODE	TYPE	LUMEN	WATT
LSP.F15.006.xx	FL15-50	6250	50
LSP.F15.012.xx	FL15-100	12500	100
LSP.F15.019.xx	FL15-150	18750	150
LSP.F15.025.xx	FL15-200	25000	200
LSP.F15.038.xx	FL15-300	37500	300

*xx=30 for 3000K xx=40 for 4000K xx=50 for 5000K

Record



CODE	TYPE	LUMEN	WATT
LSP.REC.031.xx	HD-FL02-250W	31250	250
LSP.REC.038.xx	HD-FL02-300W	37500	300
LSP.REC.050.xx	HD-FL02-400W	50000	400
LSP.REC.063.xx	HD-FL02-500W	62500	500
LSP.REC.075.xx	HD-FL02-600W	75000	600
LSP.REC.094.xx	HD-FL02-750W	93750	750
LSP.REC.125.xx	HD-FL02-1000W	125000	1000
LSP.REC.156.xx	HD-FL02-1250W	156250	1250

*xx=30 for 3000K xx=40 for 4000K xx=50 for 5000K
xx=57 for 5700K xx=65 for 6500K

Vario II



CODE	TYPE	LUMEN	WATT
LSP.VL.014.xx	FK-VL/D100W	14000	100
LSP.VL.021.xx	FK-VL/D150W	21000	150
LSP.VL.028.xx	FK-VL/D200W	28000	200
LSP.VL.042.xx	FK-VL/D300W	42000	300
LSP.VL.056.xx	FK-VL/D400W	56000	400
LSP.VL.063.xx	FK-VL/D450W	63000	450
LSP.VL.084.xx	FK-VL/D600W	84000	600

*xx=40 for 4000K xx=50 for 5000K xx=57 for 5700K

Arena Lit



CODE	TYPE	LUMEN	WATT
LSP.ARL.059.xx	FK-VD450-XXXN-HA2	58500	450
LSP.ARL.078.xx	FK-VD600-XXXN-HA2	78000	600
LSP.ARL.104.xx	FK-VD800-XXXN-HA2	104000	800

*xx=40 for 4000K xx=50 for 5000K xx=57 for 5700K

Optima



CODE	TYPE	LUMEN	WATT
LSP.OPT.056.xx	HD-FL03-400W	56000	400
LSP.OPT.070.xx	HD-FL03-500W	70000	500
LSP.OPT.084.xx	HD-FL03-600W	84000	600
LSP.OPT.112.xx	HD-FL03-800W	112000	800
LSP.OPT.140.xx	HD-FL03-1000W	140000	1000
LSP.OPT.168.xx	HD-FL03-1200W	168000	1200
LSP.OPT.224.xx	HD-FL03-1600W	224000	1600
LSP.OPT.280.xx	HD-FL03-2000W	280000	2000
LSP.OPT.336.xx	HD-FL03-2400W	336000	2400

*xx=40 for 4000K xx=50 for 5000K xx=57 for 5700K

Sunbright II



CODE	TYPE	LUMEN	WATT
LSP.SB2.045.xx	HD-SP06-300WD-X-A	45000	300
LSP.SB2.060.xx	HD-SP06-400WD-X-A	60000	400
LSP.SB2.075.xx	HD-SP06-500WD-X-A	75000	500
LSP.SB2.090.xx	HD-SP06-600WD-X-A	90000	600
LSP.SB2.098.xx	HD-SP06-750WD-X-A	975000	750
LSP.SB2.130.xx	HD-SP06-1000WD-X-A	130000	1000
LSP.SB2.156.xx	HD-SP06-1230WD-X-A	156000	1200

*xx=40 for 4000K xx=50 for 5000K xx=57 for 5700K

Pro



CODE	TYPE	LUMEN	WATT
LSP.PRO.065.xx	GL-SPL-500	65000	500
LSP.PRO.104.xx	GL-SPL-800	104000	800
LSP.PRO.130.xx	GL-SPL-1000	130000	1000
LSP.PRO.156.xx	GL-SPL-1200	156000	1200
LSP.PRO.260.xx	GL-SPL-2000	260000	2000

*xx=40 for 4000K xx=50 for 5000K xx=57 for 5700K

Architectural Illumination



CHAPTER C

Public

Illumination

Street Lights



Economy



CODE	TYPE	LUMEN	WATT
LSTR.LRS2.040.xx	LED-RS1-40	4000	40
LSTR.LRS2.060.xx	LED-RS1-60	6000	60
LSTR.LRS2.100.xx	LED-RS1-100	10000	100
LSTR.LRS2.150.xx	LED-RS1-150	15000	150
LSTR.LRS2.200.xx	LED-RS1-200	20000	200
LSTR.AD.S	adjustable - angle bracket for 60W Lighting fixture		
LSTR.AD.B	adjustable - angle bracket for 100-150-200W Lighting fixture		
LSTR.MF4	Converter Ø60 to Ø40 for street light Economy		

xx=50 for 5000K

Nova



CODE	TYPE	LUMEN	WATT
LSTR.NOV.055.xx	HL-PL04WCCXXYYZO	5600	40
LSTR.NOV.085.xx	HL-PL06WCCXXYYZO	8400	60
LSTR.NOV.110.xx	HL-PL08WCCXXYYZO	11200	80
LSTR.NOV.140.xx	HL-PL10WCCXXYYZO	14000	100
LSTR.NOV.170.xx	HL-PL12WCCXXYYZO	16800	120
LSTR.NOV.210.xx	HL-PL15WCCXXYYZO	21000	150
LSTR.NOV.260.xx	HL-PL18WCCXXYYZO	25900	185
LSTR.NOV.335.xx	HL-PL24WCCXXYYZO	33600	240
LSTR.NOV.420.xx	HL-PL30WCCXXYYZO	42000	300
LSTR.NOV.560.xx	HL-PL40WCCXXYYZO	56000	400
LSTR.NOV.700.xx	HL-PL50WCCXXYYZO	70000	500

*xx=30 for 3000K xx=40 for 4000K xx=50 for 5000K

Cronos



CODE	TYPE	LUMEN	WATT
LSTR.CRO.060.xx	LEDZ7LD40	5800	40
LSTR.CRO.085.xx	LEDZ7LD60	8400	60
LSTR.CRO.120.xx	LEDZ7LD90	11700	90
LSTR.CRO.155.xx	LEDZ7LD120	15600	120

*xx=30 for 3000K xx=40 for 4000K xx=50 for 5000K

Stellar



CODE	TYPE	LUMEN	WATT
LSTR.ST.070.xx	KN-STELLALED-100	7300	60
LSTR.ST.100.xx	KN-STELLALED-80	9500	80
LSTR.ST.130.xx	KN-STELLALED-60	13000	100
LSTR.ST.160.xx	KN-STELLALED-120	15500	120
LSTR.ST.200.xx	KN-STELLALED-150	19500	150
LSTR.ST.235.xx	KN-STELLALED-180	23500	180
LSTR.ST.260.xx	KN-STELLALED-200	26000	200

*xx=30 for 3000K xx=40 for 4000K xx=50 for 5000K

Nano



CODE	TYPE	LUMEN	WATT
LSTR.NA3.008.xx	UNI-STA7STDT-NE-1	880	8
LSTR.NA3.020.xx	UNI-STA7STDT-NE-1	2000	15
LSTR.NA3.025.xx	UNI-STA7STDT-NE-2	2600	20
LSTR.NA3.040.xx	UNI-STA7STDT-NE-3	4000	30
LSTR.NA3.050.xx	UNI-STA7STDT-NE-4	5200	40
LSTR.NA3.080.xx	UNI-STA7STDT-NE-5	8000	60
LSTR.NA3.105.xx	UNI-ST07STDT-NE-1	10500	80
LSTR.NA3.130.xx	UNI-ST07STDT-NE-2	13000	100
LSTR.NA3.155.xx	UNI-ST07STDT-NE-3	15500	120
LSTR.NA3.195.xx	UNI-ST07STDT-NE-4	19500	150

*xx=30 for 3000K xx=40 for 4000K xx=50 for 5000K

Rock



CODE	TYPE	LUMEN	WATT
LSTR.R13.040.xx	D-170S1LED30-16	3900	30
LSTR.R13.050.xx	D-170S1LED40-24	5200	40
LSTR.R13.080.xx	D-170S1LED60-24	7800	60
LSTR.R13.100.xx	D-170SLED80-32	10400	80
LSTR.R13.130.xx	D-170SLED100-48	13000	100
LSTR.R13.150.xx	D-170MLED120-64	15600	120
LSTR.R13.200.xx	D-170MLED150-64	19500	150
LSTR.R13.240.xx	D-170MLED180-64	23400	180

*xx=30 for 3000K xx=40 for 4000K xx=50 for 5000K

Jade



CODE	TYPE	LUMEN	WATT
LSTR.JD.036.xx	JD-1047A	3600	30
LSTR.JD.048.xx	JD-1047B	4800	40
LSTR.JD.060.xx	JD-1047C	6000	50
LSTR.JD.072.xx	JD-1047D	7200	60
LSTR.JD.084.xx	JD-1047E	8400	70
LSTR.JD.120.xx	JD-1047F	12000	100
LSTR.JD.144.xx	JD-1047G	14400	120
LSTR.JD.180.xx	JD-1047H	18000	150
LSTR.JD.240.xx	JD-1047I	24000	200

*xx=30 for 3000K xx=40 for 4000K xx=50 for 5000K

Beluga



CODE	TYPE	LUMEN	WATT
LSTR.BEL.021.xx	UNI-STB1-1-15	2100	15
LSTR.BEL.035.xx	UNI-STB1-1-25	3500	25
LSTR.BEL.050.xx	UNI-STB1-1-35	4900	35
LSTR.BEL.065.xx	UNI-STB1-1-45	6300	45
LSTR.BEL.085.xx	UNI-STB1-2-60	8500	60
LSTR.BEL.125.xx	UNI-STB1-3-90	12500	90
LSTR.BEL.170.xx	UNI-STB2-5-120	17000	120

*xx=30 for 3000K xx=40 for 4000K xx=50 for 5000K

Ledolphin



CODE	TYPE	LUMEN	WATT
LSTR.LD1.020.xx	UNI-STA8-1-015	1800	15
LSTR.LD1.030.xx	UNI-STA8-1-025	3000	25
LSTR.LD1.040.xx	UNI-STA8-1-035	4200	35
LSTR.LD1.055.xx	UNI-STA8-1-045	5400	45
LSTR.LD1.070.xx	UNI-STA8-2-060	7200	60
LSTR.LD1.110.xx	UNI-STA8-3-090	10800	90
LSTR.LD1.145.xx	UNI-STA8-3-120	14400	120
LSTR.LD1.180.xx	UNI-STA8-4-150	18000	150
LSTR.LD1.215.xx	UNI-STA8-4-180	21600	180
LSTR.LD1.240.xx	UNI-STA8-4-200	24000	200

*xx=30 for 3000K xx=40 for 4000K xx=50 for 5000K

ECO



CODE	TYPE	LUMEN	WATT
LSTR.FE1.020.xx	ECO-8	2000	20
LSTR.FE1.030.xx	ECO-12	3000	29
LSTR.FE1.040.xx	ECO-16	3900	38
LSTR.FE1.050.xx	ECO-24	5200	50

*xx=30 for 3000K xx=40 for 4000K xx=50 for 5000K

Future Mini



CODE	TYPE	LUMEN	WATT
LSTR.FN1.040.xx	Future Mini-16	3800	38
LSTR.FN1.055.xx	Future Mini-24	5700	55
LSTR.FN1.080.xx	Future Mini-32	8000	73
LSTR.FN1.100.xx	Future Mini-40	10000	90

*xx=30 for 3000K xx=40 for 4000K xx=50 for 5000K

Future



CODE	TYPE	LUMEN	WATT
LSTR.F1.090.xx	Future-40 90W	9100	90
LSTR.F1.115.xx	Future-48 110W	11500	110
LSTR.F1.125.xx	Future-64 120W	12500	120
LSTR.F1.145.xx	Future-64 140W	14500	140
LSTR.F1.160.xx	Future-80 150W	16000	150
LSTR.F1.190.xx	Future-80 180W	19000	180
LSTR.F1.220.xx	Future-100 200W	22000	200

*xx=30 for 3000K xx=40 for 4000K xx=50 for 5000K

FutureMaxi



CODE	TYPE	LUMEN	WATT
LSTR.FMX.215.xx	Future Maxi-96	21500	215
LSTR.FMX.225.xx	Future Maxi-100	22500	225
LSTR.FMX.250.xx	Future Maxi-112	25000	250
LSTR.FMX.265.xx	Future Maxi-120	26500	265
LSTR.FMX.285.xx	Future Maxi-128	28500	285
LSTR.FMX.300.xx	Future Maxi-140	30000	300

*xx=30 for 3000K xx=40 for 4000K xx=50 for 5000K

HPS Street Light, Spark



CODE	TYPE	SOCKET	WATT
LSTR.MSP.070	KN-STSP(HPS70W)	E27	70
LSTR.MSP.150	KN-STSP(HPS150W)	E40	150
LSTR.MSP.250	KN-STSP(HPS250W)	E40	250





Industrial Lights for Airports, Ports, Logistics

Ariadne



CODE	TYPE	LUMEN	WATT
LHM.ARD.030.xx	HL-HP210W	29400	210
LHM.ARD.034.xx	HL-HP240W	33600	240
LHM.ARD.045.xx	HL-HP320W	44800	320
LHM.ARD.056.xx	HL-HP400W	56000	400
LHM.ARD.067.xx	HL-HP475W	66500	475
LHM.ARD.080.xx	HL-HP570W	79800	570
LHM.ARD.085.xx	HL-HP631W	85000	631
LHM.ARD.098.xx	HL-HP750W	97500	750

*xx=30 for 3000K xx=40 for 4000K xx=50 for 5000K xx=57 for 5700K

Tunnel Lights



T3



CODE	TYPE	LUMEN	WATT
LTU.T3.070.xx	DMTL-T3-060	6900	60
LTU.T3.085.xx	DMTL-T3-075	8625	75
LTU.T3.100.xx	DMTL-T3-090	10350	90
LTU.T3.120.xx	DMTL-T3-105	12075	105
LTU.T3.140.xx	DMTL-T3-120	13800	120
LTU.T3.170.xx	DMTL-T3-150	17250	150
LTU.T3.200.xx	DMTL-T3-180	20700	180
LTU.T3.240.xx	DMTL-T3-210	24150	210
LTU.T3.280.xx	DMTL-T3-240	27600	240
LTU.T3.310.xx	DMTL-T3-270	31050	270
LTU.T3.350.xx	DMTL-T3-300	34500	300

*xx=30 for 3000K xx=40 for 4000K xx=50 for 5000K

Bright Moon



CODE	TYPE	LUMEN	WATT
LTU.BM.050.xx	UNI-TND3-1	5200	40
LTU.BM.100.xx	UNI-TND3-2	10400	80
LTU.BM.130.xx	UNI-TND3-3	13000	100
LTU.BM.150.xx	UNI-TND3-3	15600	120
LTU.BM.200.xx	UNI-TND3-4	20800	160
LTU.BM.260.xx	UNI-TND3-5	26000	200
LTU.BM.310.xx	UNI-TND3-6	31200	240

*xx=30 for 3000K xx=40 for 4000K xx=50 for 5000K

City Lights



Lance



CODE	TYPE	LUMEN	WATT
LP.LAN.040.xx	KN-GLLA-45W	4100	45
LP.LAN.055.xx	KN-GLLA-60W	5400	60

*xx=27 for 2700K xx=40 for 4000K

Levent



CODE	TYPE	LUMEN	WATT
LP.LEV.040.xx	KN-GLLE-45W	4100	45
LP.LEV.055.xx	KN-GLLE-60W	5400	60

*xx=27 for 2700K xx=40 for 4000K

Vintage



CODE	TYPE	LUMEN	WATT
LP.T75.035.xx	T-75MNLED35-24	3500	35
LP.T75.060.xx	T-75MNLED60-24	6000	60
LP.T75.075.xx	T-75MNLED75-32	7500	75

*xx=30 for 3000K xx=40 for 4000K xx=50 for 5000K

Vintage Mini



CODE	TYPE	LUMEN	WATT
LP.VNM.020.xx	YZTL859-25W	2200	25
LP.VNM.030.xx	YZTL859-25W	3000	35

*xx=30 for 3000K xx=40 for 4000K xx=50 for 5000K

Perm



CODE	TYPE	LUMEN	WATT
LP.PRM.030.xx	YZTL856A-30W	2700	30
LP.PRM.040.xx	YZTL856A-45W	4000	45
LP.PRM.055.xx	YZTL856A-60W	5500	60
LP.PRM.065.xx	YZTL856B-70W	6300	70
LP.PRM.090.xx	YZTL856B-100W	9000	100
LP.PRM.110.xx	YZTL856B-120W	11000	120

*xx=30 for 3000K xx=40 for 4000K xx=50 for 5000K

Classic



CODE	TYPE	LUMEN	WATT
LP.GCL.030.xx	JD-1044A-30WXTE	3000	30
LP.GCL.060.xx	JD-1044A-60WXTE	6000	60
LP.GCL.100.xx	JD-1044A-100WXTE	10000	100

*xx=30 for 3000K xx=40 for 4000K xx=50 for 5000K

Lunar L01



CODE	TYPE	LUMEN	WATT
LP.L01.035.xx	T-005001-36W	3600	36
LP.L01.050.xx	T-005001-48W	4800	48
LP.L01.060.xx	T-005001-60W	6000	60

*xx=30 for 3000K xx=40 for 4000K xx=50 for 5000K

Lunar L09

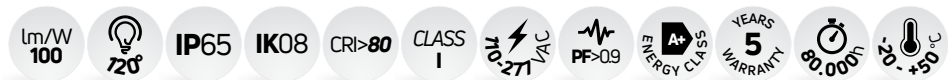

CODE	TYPE	LUMEN	WATT
LP.L09.035.xx	T-005009-36W	3600	36
LP.L09.050.xx	T-005009-48W	4800	48
LP.L09.060.xx	T-005009-60W	6000	60

*xx=30 for 3000K xx=40 for 4000K xx=50 for 5000K

Lunar L17



CODE	TYPE	LUMEN	WATT
LP.L17.030.xx	T-005017-36W	3200	36
LP.L17.040.xx	T-005017-48W	4200	48
LP.L17.055.xx	T-005017-60W	5400	60

*xx=30 for 3000K xx=40 for 4000K xx=50 for 5000K

Pearl



CODE	TYPE	LUMEN	WATT
LP.BAL.030.xx	T-10ALED30	3000	30
LP.BAL.040.xx	T-10ALED40	4000	40
LP.BAL.060.xx	T-10ALED60	6000	60
LP.BAL.080.xx	T-10ALED80	8000	80

*xx=30 for 3000K xx=40 for 4000K xx=50 for 5000K

Crown



CODE	TYPE	LUMEN	WATT
LP.CRW.045.xx	T-85MNLED40-24	4400	40
LP.CRW.065.xx	T-85MNLED60-24	6600	60
LP.CRW.085.xx	T-85MNLED80-32	8800	80

*xx=30 for 3000K xx=40 for 4000K xx=50 for 5000K

Villa



CODE	TYPE	LUMEN	WATT
LP.VIL.025.xx	UNI-YA05-1-020	2400	20
LP.VIL.035.xx	UNI-YA05-1-030	3600	30
LP.VIL.050.xx	UNI-YA05-1-040	4800	40
LP.VIL.060.xx	UNI-YA05-1-050	6000	50
LP.VIL.075.xx	UNI-YA05-1-060	7200	60
LP.VIL.085.xx	UNI-YA05-1-070	8400	70
LP.VIL.095.xx	UNI-YA05-1-080	9600	80

*xx=30 for 3000K xx=40 for 4000K xx=50 for 5000K

Rodo



CODE	TYPE	LUMEN	WATT
LPT21.035.xx	T-21LLED35-24	3500	35
LPT21.060.xx	T-21LLED60-24	6000	60
LPT21.075.xx	T-21LLED75-36	7500	75
LPT21.100.xx	T-21LLED75-48	10000	100

*xx=30 for 3000K xx=40 for 4000K xx=50 for 5000K

Square



CODE	TYPE	LUMEN	WATT
LPT70.035.xx	T-70NLED35-32	3500	35
LPT70.060.xx	T-70NLED60-32	6000	60
LPT70.075.xx	T-70NLED75-48	7500	75

*xx=30 for 3000K xx=40 for 4000K xx=50 for 5000K

Plaza U01



CODE	TYPE	LUMEN	WATT
LP.U01.040.xx	AUA7001-40	4100	40
LP.U01.055.xx	AUA7001-55	5600	55
LP.U01.070.xx	AUA7001-70	7200	70

*xx=30 for 3000K xx=40 for 4000K xx=50 for 5000K

Plaza U11



CODE	TYPE	LUMEN	WATT
LP.U11.040.xx	AUA7011-40	4100	40
LP.U11.070.xx	AUA7011-70	7200	70

*xx=30 for 3000K xx=40 for 4000K xx=50 for 5000K

Plaza U15



CODE	TYPE	LUMEN	WATT
LP.U15.040.xx	AUA115B-40	4100	40
LP.U15.070.xx	AUA115B-70	7200	70

*xx=30 for 3000K xx=40 for 4000K xx=50 for 5000K

Plaza U81



CODE	TYPE	LUMEN	WATT
LP.U81.040.xx	AUA6081-35	3600	35
LP.U81.055.xx	AUA6081-55	5500	55
LP.U81.070.xx	AUA6081-70	7000	70
LP.U81.100.xx	AUA6081-105	10600	105

*xx=30 for 3000K xx=40 for 4000K xx=50 for 5000K

Plaza U91



CODE	TYPE	LUMEN	WATT
LP.U91.040.xx	AUA5191-40	4100	40
LP.U91.070.xx	AUA5191-70	7200	70

*xx=30 for 3000K xx=40 for 4000K xx=50 for 5000K

Plaza U93



CODE	TYPE	LUMEN	WATT
LP.U93.040.xx	AUA5193-40	4100	40
LP.U93.070.xx	AUA5193-70	7200	70

*xx=30 for 3000K xx=40 for 4000K xx=50 for 5000K

Plaza U94



CODE	TYPE	LUMEN	WATT
LP.U94.040.xx	AUA5194-40	4100	40
LP.U94.070.xx	AUA5194-70	7200	70

*xx=30 for 3000K xx=40 for 4000K xx=50 for 5000K

Opera



CODE	TYPE	LUMEN	WATT
LP.OPR.020.xx	UNI-YA03YA03-NE-A1	1980	18
LP.OPR.030.xx	UNI-YA03YA03-NE-A3	2750	25
LP.OPR.040.xx	UNI-YA03YA03-NE-A5	3850	35
LP.OPR.050.xx	UNI-YA03YA03-NE-A7	4950	45
LP.OPR.070.xx	UNI-YA03YA03-NE-A9	7150	65
LP.OPR.080.xx	UNI-YA03YA03-NE-A11	8160	80

*xx=30 for 3000K xx=40 for 4000K xx=50 for 5000K

Universal



CODE	TYPE	LUMEN	WATT
LP.UN1.040.xx	UNIVERSAL-GL-1-16	3800	38
LP.UN1.055.xx	UNIVERSAL-GL-1-24	5750	53
LP.UN1.075.xx	UNIVERSAL-GL-1-32	7600	70

*xx=30 for 3000K xx=40 for 4000K xx=50 for 5000K

Universal 130



CODE	TYPE	LUMEN	WATT
LP.UN3.035.xx	UNIVERSAL-GL-1-24	3500	27
LP.UN3.045.xx	UNIVERSAL-GL-1-32	4500	35
LP.UN3.070.xx	UNIVERSAL-GL-1-48	7100	55
LP.UN3.090.xx	UNIVERSAL-GL-1-64	9100	70

*xx=30 for 3000K xx=40 for 4000K xx=50 for 5000K



Venus



CODE	TYPE	LUMEN	WATT
LPVN1.040.xx	VENUS-16	3800	38
LPVN1.060.xx	VENUS-24	5800	55
LPVN1.080.xx	VENUS-32	7800	73

*xx=30 for 3000K xx=40 for 4000K xx=50 for 5000K



Venus 130



CODE	TYPE	LUMEN	WATT
LPVN3.055.xx	VENUS-24	5300	41
LPVN3.070.xx	VENUS-32	7200	56

*xx=30 for 3000K xx=40 for 4000K xx=50 for 5000K



T101



CODE	TYPE	LUMEN	WATT
LP.KT2.050.xx	T-101LED50C-H270	5000	50
LP.KT3.050.xx	T-101LED50C-H350	5000	50

*xx=30 for 3000K xx=40 for 4000K xx=50 for 5000K

Glossary

GEYER



Beam Angle



TUV certificate



Lamp Type



Dimmable



Unified Glare Rating



Driver Type



Color Rendering Index



CE marking



Horizontal Adjustable



Input Voltage



Dimming 0-10V



4 wires



Energy Class



Dimming Dali



Maximum pieces in row



Warranty



Polycarbonate+Polycarbonate Body



G9 Base



Counter



Protection Against Mechanical Impacts



E14 base



Ingress Protection Rating



Lumen per Watt



Polycarbonate Body



Power Factor



SMD chip



GS Certificate



Risk Group



3 Phase



Beam Light Length



Temperature



LED



Battery 18650 Lithium



Colour Rendering Index



E27 Base



ABS + Polycarbonate body



Ultra Violet



Maximum Watt



Battery LiFePo 32700



Acrylic Glass



Adjustable



Auto dimming







IEC Class



GU10 Base





Motion Sensor





-  <https://www.facebook.com/geyerhellas>
-  <https://www.instagram.com/geyerhellas>
-  <https://www.linkedin.com/company/geyerhellas>
-  <https://www.youtube.com/user/geyerhellas>

GEYER HELLAS

Main Factory

-  Drosia Chalkis, Evia, Greece,
Postal Code 34100
-  +30 22210-98711, +30 22210-97127
-  +30 22210-97144

Thessaloniki branch

-  31 Filiras Str., P. Melas, Thessaloniki, Greece
Postal Code 56429
-  +30 2310-544308, +30 2310-544853
-  +30 2310-544711
-  cs@geyer.gr

